

## Portail coulissant

### Motorisation à crémaillères

Automation kit with nylon racks  
for sliding gate

Motorizzazione con cremagliere  
per cancello scorrevole

Kit automatismos con cremalleras  
para puerta corredera



Installation  
Utilisation  
faciles



Forte  
capacité

24V



Moteurs  
silencieux



Fiabilité  
accrue







Carte  
électronique  
P501BU-PCB1

### CAPACITÉS



6 m max  
500 kg max



-  Notice d'utilisation et d'installation
-  Installation and user manual
-  Manuale d'installazione e uso
-  Instrucciones de uso e instalación

# SOMMAIRE

<b>A - Consignes de sécurité</b> .....	<b>2</b>
<b>B - Descriptif</b> .....	<b>3</b>
B1 - Contenu du kit .....	3
B2 - Dimensions.....	3
B3 - Description de la motorisation .....	3
<b>C- Câblage / Installation</b> .....	<b>4</b>
C1 - Installation de l'automatisme .....	4
C2 - Installation des moteurs et des crémaillères .....	4
C3 - Déverrouillage d'urgence .....	7
C4 - Schéma de câblage .....	8
C5 - Installation et raccordement.....	9
<b>D- Réglage/Utilisation</b> .....	<b>12</b>
<b>E- Caractéristiques techniques</b> .....	<b>19</b>
<b>F- Maintenance</b> .....	<b>21</b>
<b>G- Assistance technique</b> .....	<b>21</b>
<b>H- Garantie</b> .....	<b>22</b>
<b>I- Avertissements</b> .....	<b>22</b>

## A- CONSIGNES DE SÉCURITÉ

 **MISE EN GARDE : Instructions importantes de sécurité. Il est important pour la sécurité des personnes de suivre ces instructions. Conserver ces instructions.**

**MISE EN GARDE : Instructions importantes de sécurité. Suivre toutes les instructions car une installation incorrecte peut entraîner des blessures graves.**

Ce produit est uniquement destiné à l'automatisation d'un portail coulissant pour usage de type «résidentiel». L'installation de l'alimentation électrique doit être conforme aux normes en vigueur dans le pays où est installé le produit (NF C 15-100 pour la France) et doit être faite par un personnel qualifié.

L'arrivée électrique du secteur doit être protégée contre les surtensions par un disjoncteur adapté et d'un dispositif différentiel.

 **AVERTISSEMENT:** La motorisation doit être déconnectée de sa source d'alimentation pendant le nettoyage, la maintenance et le remplacement de pièces.

L'installation nécessite un personnel qualifié avec des compétences mécaniques et électriques.

Assurez-vous que la plage de température indiquée sur la motorisation est adaptée à l'emplacement d'installation. Pour remplacer ou réparer le système motorisé, utilisez uniquement des pièces d'origine.

- Cet appareil peut être utilisé par des enfants âgés d'au moins 8 ans et par des personnes ayant des capacités physiques, sensorielles, ou mentales réduites ou dénuées d'expérience ou de connaissance, s'ils (si elles) sont correctement surveillé(e)s ou si des instructions relatives à l'utilisation de l'appareil en toute sécurité leur ont été données et si les risques encourus ont été appréhendés. Les enfants ne doivent pas jouer avec l'appareil. Le nettoyage et l'entretien par l'utilisateur ne doivent pas être effectués par des enfants sans surveillance.

- Ne pas laisser les enfants jouer avec l'appareil ou ses commandes, y compris les télécommandes.

- L'activation du dispositif de débrayage manuel peut déclencher un mouvement incontrôlé de la partie entraînée en raison de défaillances mécaniques ou d'une situation de perte d'équilibrage.

- Avant d'installer la motorisation, vérifier que la partie entraînée est en bon état mécanique, qu'elle est correctement équilibrée et qu'elle ouvre et se ferme correctement.

- La motorisation ne peut pas être utilisée avec une partie entraînée incorporant un portillon.

- S'assurer que l'écrasement entre la partie entraînée et les parties fixes environnantes dû au mouvement d'ouverture de la partie entraînée est évité.

- Après installation, s'assurer que le mécanisme est correctement réglé et que le système de protection et tout dispositif de débrayage manuel fonctionnent correctement.

- Fixer de façon permanente auprès de l'organe de manoeuvre du dispositif de débrayage manuel l'étiquette relative à ce dispositif.

N'utilisez la télécommande que lorsque vous avez une vue complète du portail.

En cas de doute, ne jamais faire fonctionner l'installation au risque de l'endommager.

## B- DESCRIPTIF

### B1- Contenu du kit

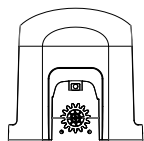

1 moteur (carte électronique + module Wi-Fi)

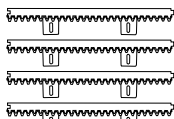

crémaillères (4m)  
AAM0098



2 télécommandes  
AAM0050



1 feu clignotant blanc à LED  
AAM0111

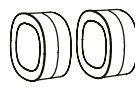

2 photocellules  
AAM0036

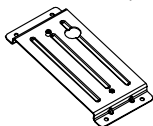

support de fixation moteur

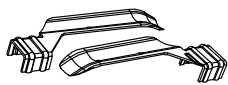

fins de course métalliques



visserie



clé de déverrouillage



1 notice

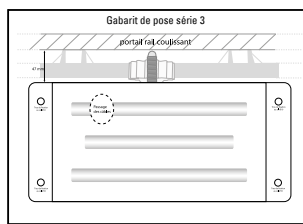

gabarit de pose

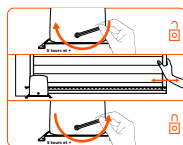

sticker de déverrouillage

### B2- Dimensions

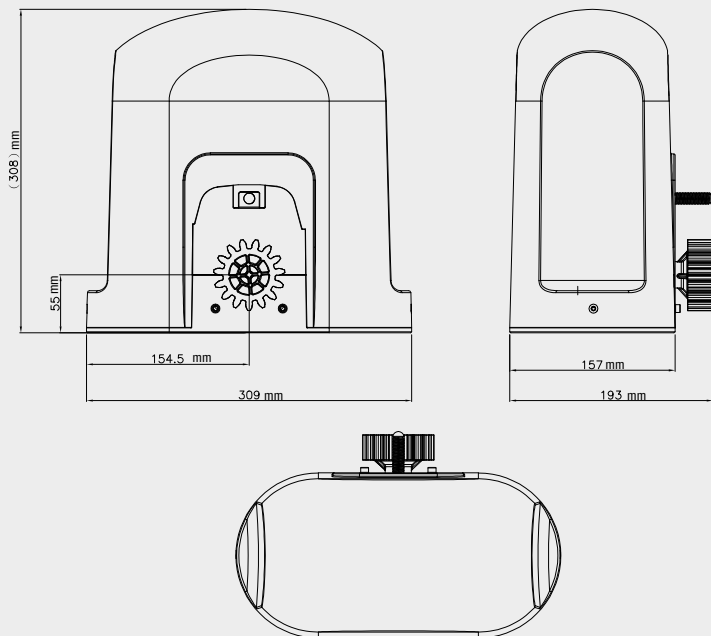

## B3- Description de la motorisation

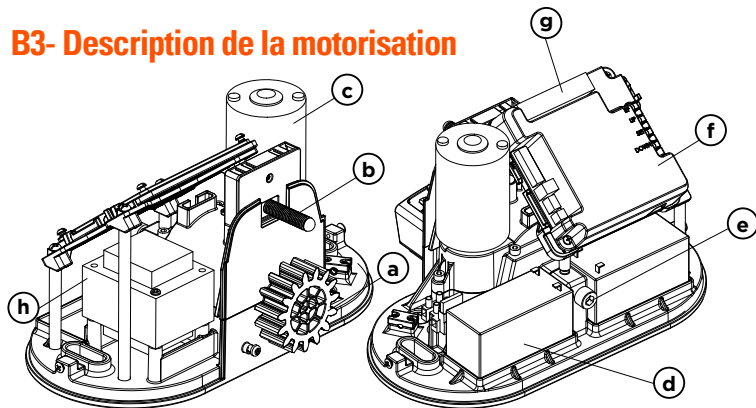

- (a)** Motoréducteur
- (b)** Fin de course
- (c)** Moteur 24V DC
- (d)** Batteries de secours (option)
- (e)** Déverrouillage
- (f)** Carte électronique
- (g)** Bornier de raccordement
- (h)** Transformateur 24V AC

## C- CÂBLAGE / INSTALLATION

### C1- Installation de l'automatisme

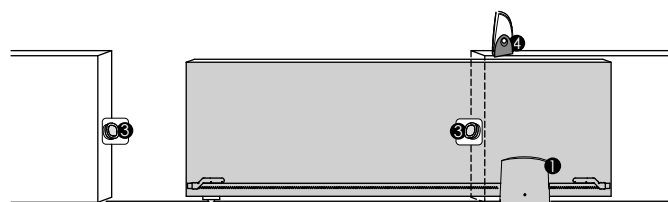

- (1)** Motorisation de portail coulissant 24V
- (2)** Télécommande 4 canaux
- (3)** Photocellules
- (4)** Feu clignotant 24V avec antenne intégrée



### C2- Installation du moteur et des crémaillères

La pose de votre motorisation sur une base béton est privilégiée :

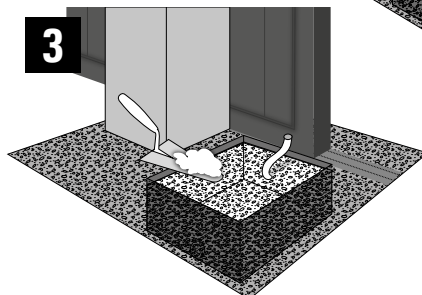
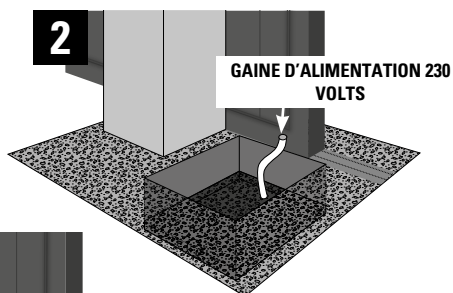
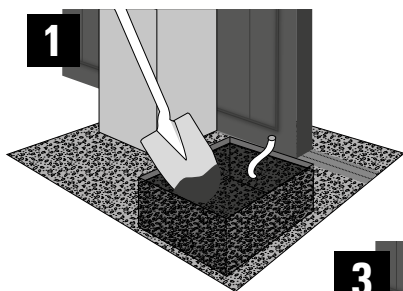

Positionnez la plaque de support moteur pour déterminer les emplacements de vos perçages.  
Elle doit être parfaitement parallèle au portail :

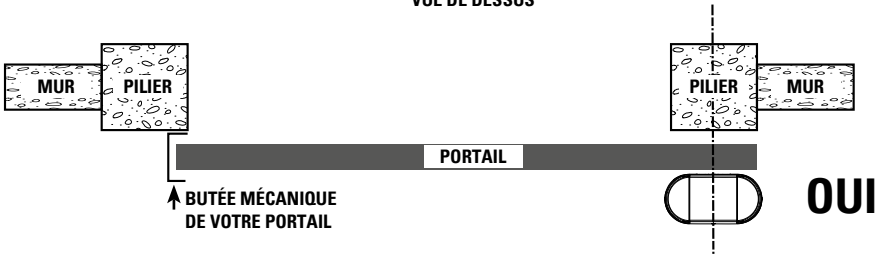
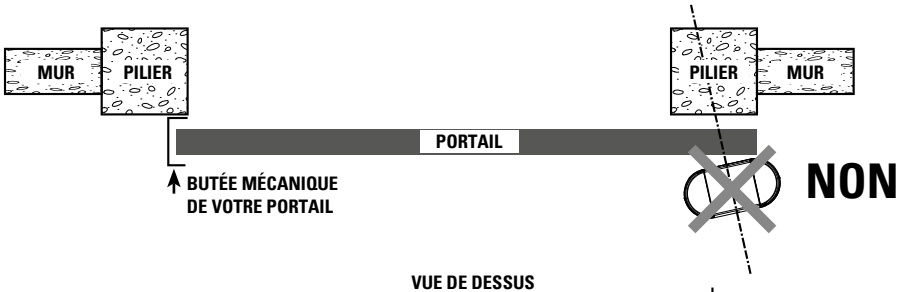
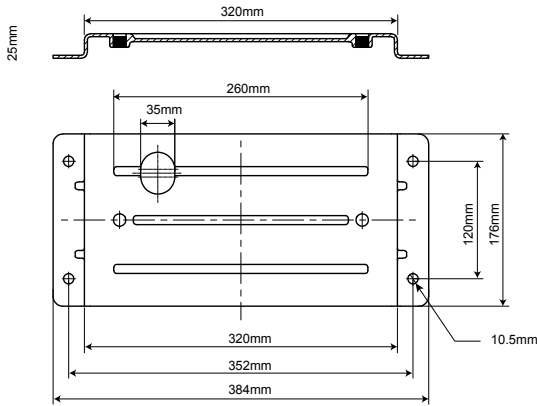

Le bord de la plaque de fixation doit se trouver à 5 cm du bord du portail.  
Vous pouvez utiliser le gabarit de pose pour faciliter l'installation

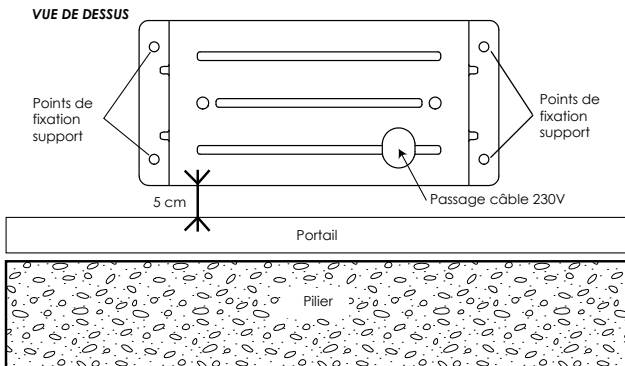

Percez votre support béton et installez vos 4 chevilles métalliques ou à scellement chimique pour fixer votre plaque de support moteur. Passez tous les câbles d'alimentation et d'accessoires. Assurez-vous à l'aide d'un niveau à bulle que la plaque de fixation du moteur soit bien de niveau. Positionnez votre moteur et boulonnez le avec les deux vis fournies.

### Fixation de la crémaillère :

Les crémaillères fournies, en matériau thermoplastique avec insert acier sont adaptées pour des portails d'un poids de 500 Kg. Elles se montent aisément sur le portail, par simple vissage. Vis auto-foreuses fournies. Si votre portail par sa construction, n'autorise pas le montage direct des crémaillères, vous devez créer une nouvelle base d'appui :

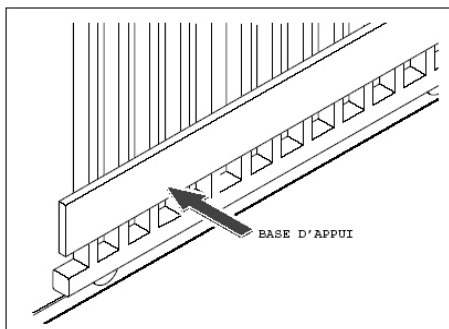

Pour positionner la première crémaillère, posez-la en respectant un espace de 2 mm entre la roue crantée du moteur et la crémaillère comme indiqué sur le schéma ci-dessous :

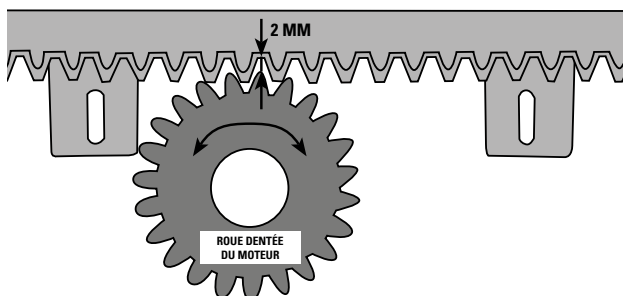

Puis tracez vos marquages pour visser les vis auto-foreuses comme indiqué ci-dessous :

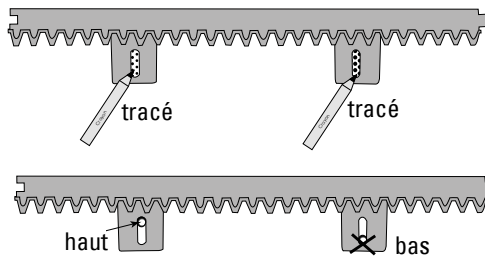
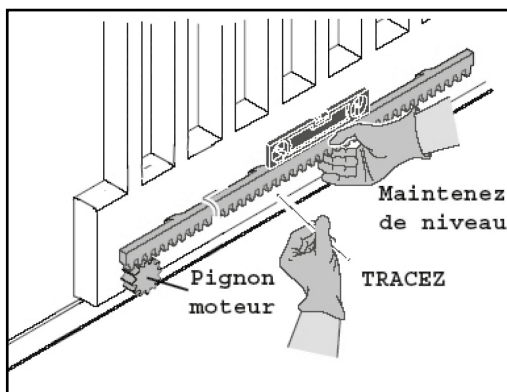

Vissez la vis auto-foreuse vers le haut du trou oblong de votre crémaillère.

Vérifiez bien que la roue crantée de votre moteur occupe toute la surface de la crémaillère :

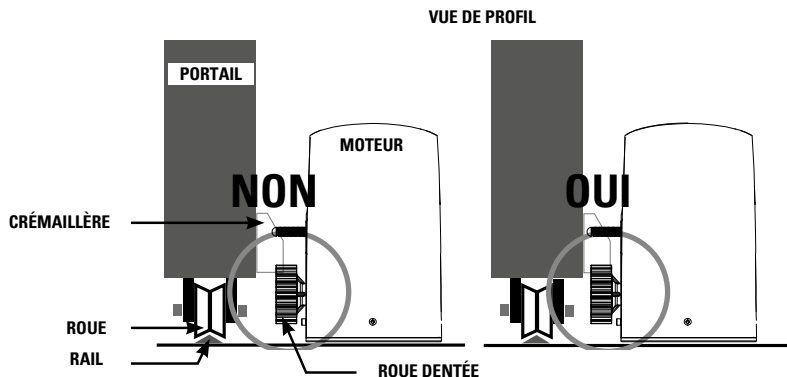

### Positionner les fins de course sur la crémaillère

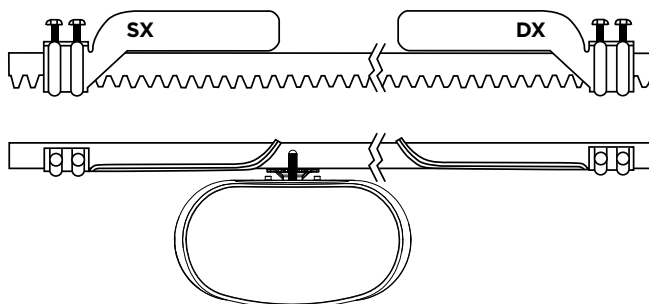

### C3 - Déverrouillage d'urgence

En cas de coupure de courant ou pour programmer votre automatisme de portail, vous pouvez déverrouiller manuellement le moteur :

Placez-vous du côté intérieur du portail. Introduisez la clé à six pans servant au déverrouillage, puis la visser entre 5 et 10 fois. Vous pouvez désormais ouvrir le portail à la main.

Pour verrouiller de nouveau le moteur, introduisez la clé à six pans servant au déverrouillage, puis dévisser entre 5 et 10 fois dans l'autre sens.

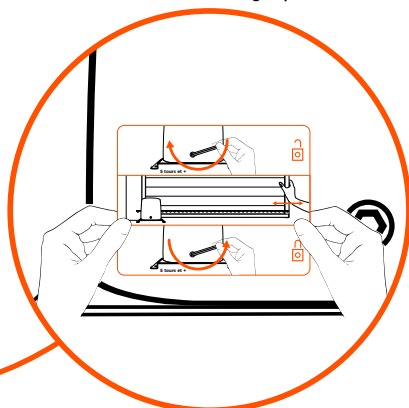
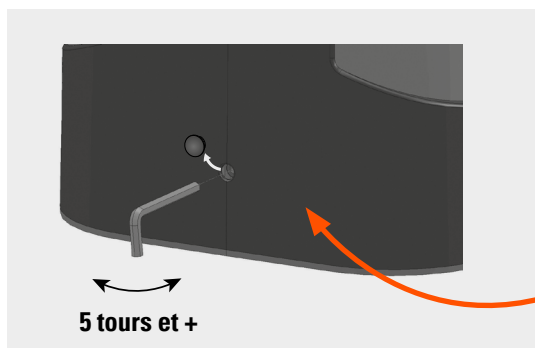

Fixer de façon permanente auprès de l'organe de manoeuvre du dispositif de débrayage manuel, l'étiquette relative à ce dispositif.

# C4- Schéma de câblage

Figure 1

**câblage impératif en :**

▲  $\geq 0.5 \text{ mm}^2$

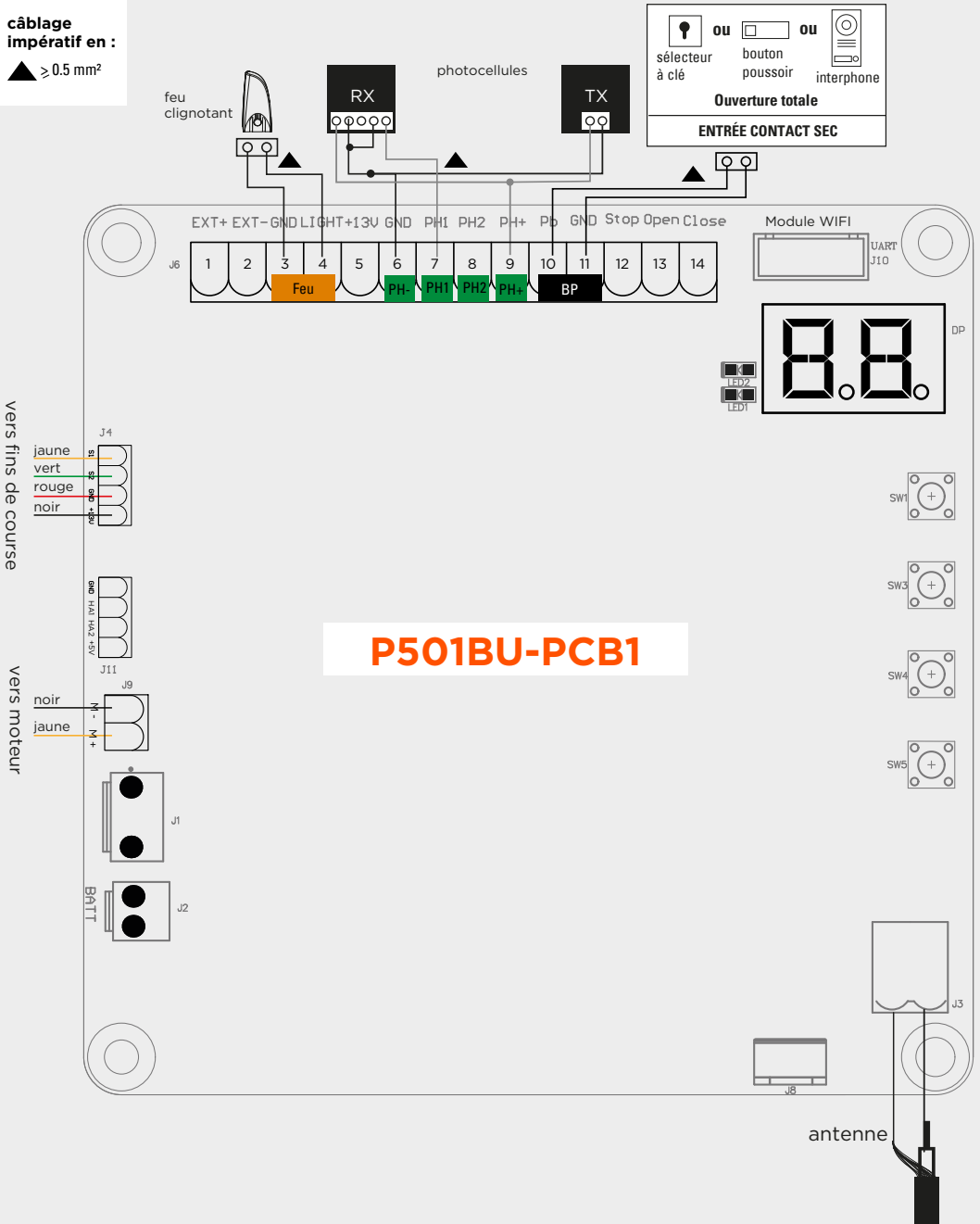

**P501BU-PCB1**



## C5- Installation et raccordement

### Branchement de l'alimentation 230 volts

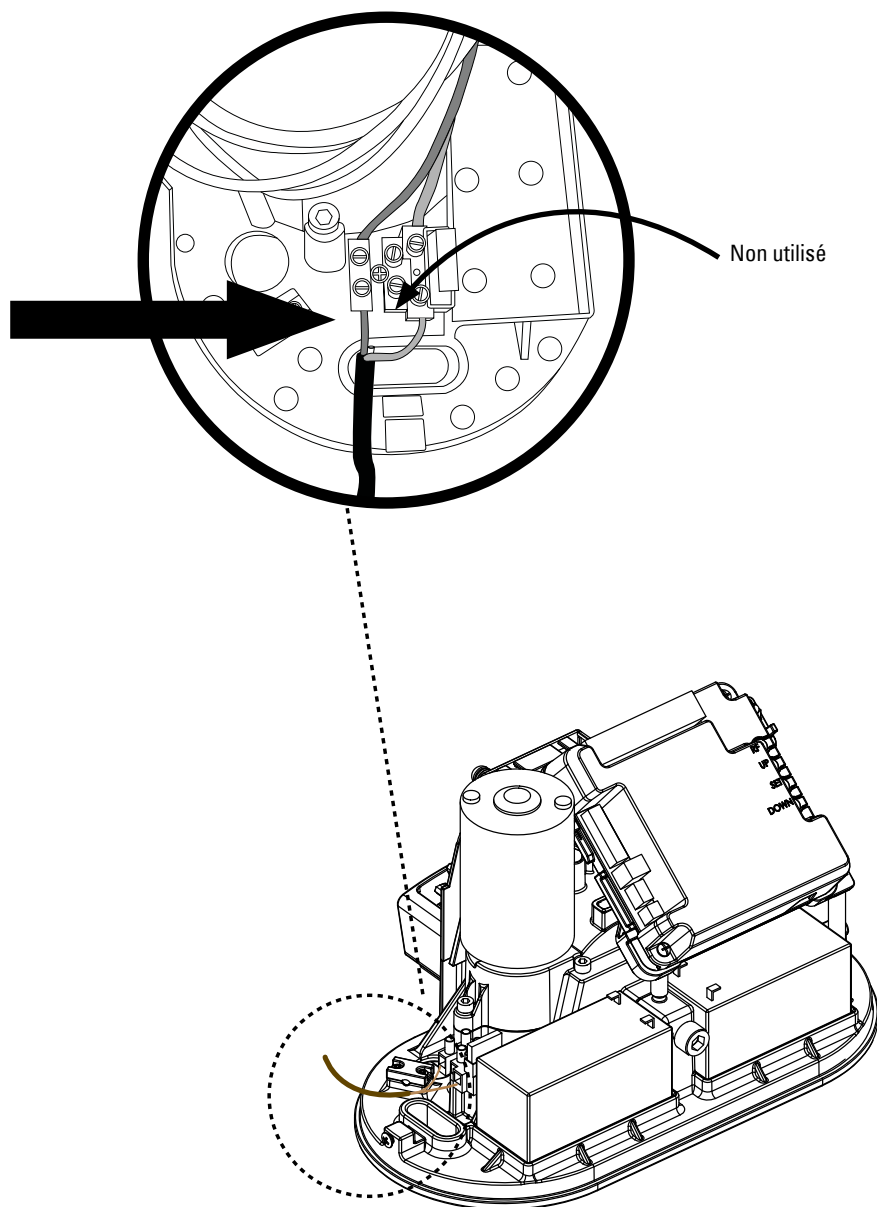

## Feu clignotant LED

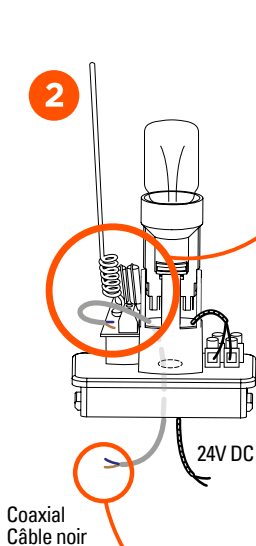
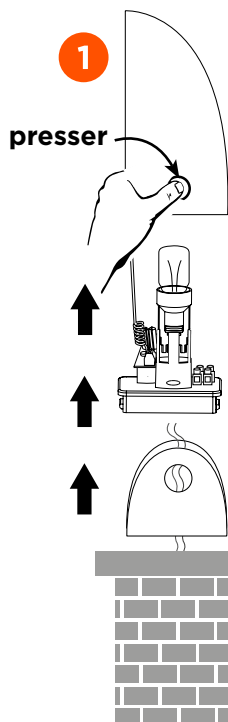

Si vous souhaitez améliorer la portée de vos télécommandes, vous pouvez brancher l'antenne située dans le feu clignotant avec câble coaxial type RG58 (non fourni). Dans ce cas, vous devez déconnecter l'antenne d'origine. Branchez le cuivre central du câble coaxial sur la borne «ANT» et la tresse sur la borne «GND», côté antenne et côté carte électronique.

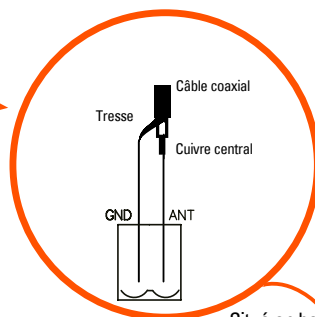

Situé en bas à droite du PCB

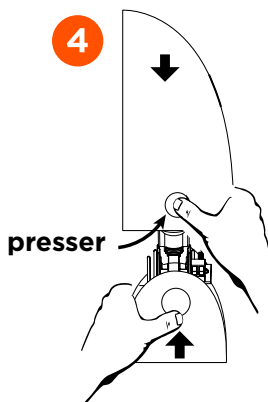
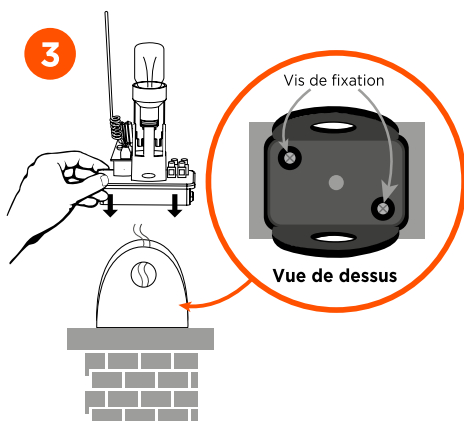

## Photocellules

Les photocellules sont des dispositifs de sécurité pour les portails automatiques. Elles sont composées d'un émetteur et d'un récepteur et elles se déclenchent lorsque la trajectoire du faisceau est interrompue.

### ÉTAPE 1

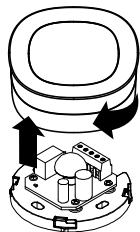

### ÉTAPE 2

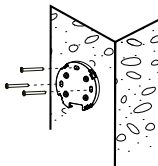

### ÉTAPE 3

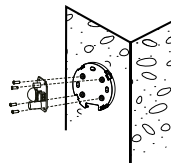

### ÉTAPE 4

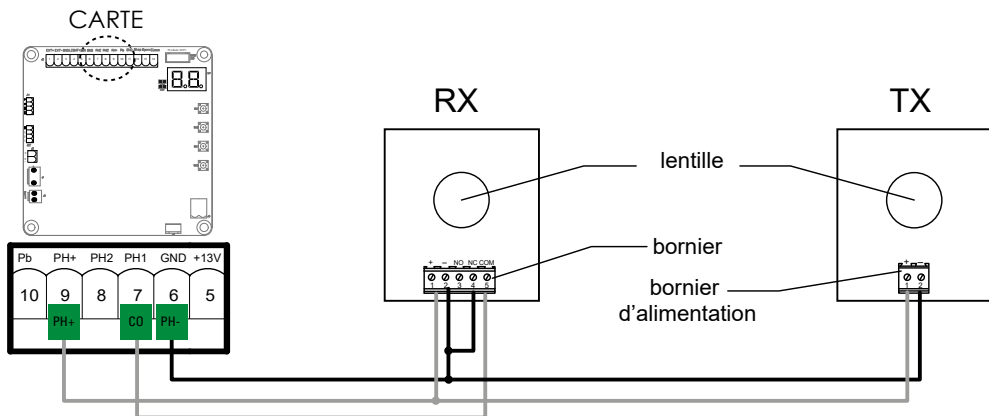

Après le branchement de vos photocellules, n'oubliez pas d'aller modifier le programme H et réglez-le sur H-1 pour rendre vos photocellules actives. Sinon, elles n'auront aucun effet sur le fonctionnement de votre motorisation (voir page 19)

### ÉTAPE 5

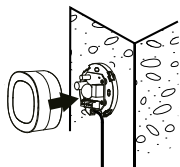

type de câble :  
0.5 mm<sup>2</sup>



Alignement



Alignement

## D- RÉGLAGE/UTILISATION

La motorisation est équipée d'un module Wi-Fi qui vous permettra d'utiliser et de paramétrer votre motorisation depuis votre smartphone. Vous avez néanmoins également la possibilité de procéder aux réglages de façon traditionnelle.

Les deux types de réglage seront différenciés comme ci-dessous :



Paramétrages traditionnels



Paramétrages via smartphone

### D1- Module Wi-Fi

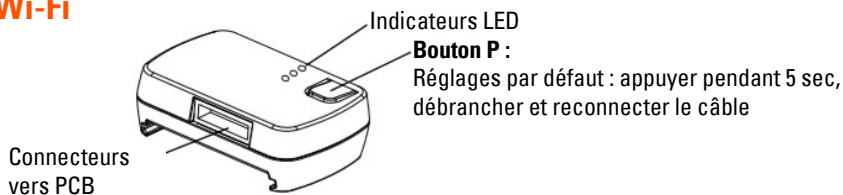

Si vous désirez programmer le module, appuyez sur le bouton P et suivez les étapes décrites au paragraphe D2

• **Détail des LED :**

**Bleu :** La LED clignotera pendant l'appairage Wi-Fi, et restera allumée quand l'appairage est réussi.

**Vert :** La LED clignotera si le module Wi-Fi reçoit un signal de l'application.

*Si le Wi-Fi est déconnecté, la LED verte clignotera continuellement et s'éteindra lorsque le Wi-Fi sera de nouveau connecté.*

**Rouge :** Système déconnecté ou mot de passe Wi-Fi incorrect.

• La portée Wi-Fi entre la box et le module Wi-Fi est de 30 m en champ libre.



Portée en champ libre

30 m

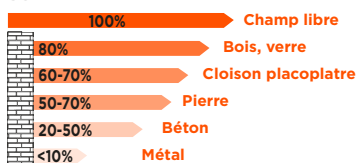

### D2- Installation de l'application et de votre appareil

**1** Téléchargez l'application **H'Access** (disponible sur iOS et Android)



H'Access

**2** Inscrivez-vous à l'aide d'un mot de passe et d'un identifiant

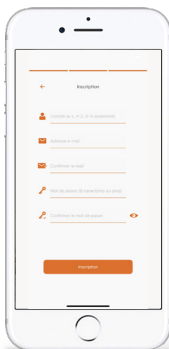

**3** Ajouter votre motorisation et cliquez sur le +

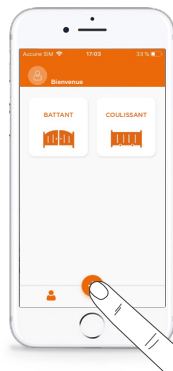

**4** Choisissez l'appareil à ajouter

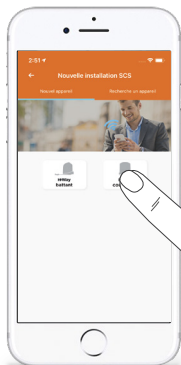

**5** Entrez votre code Wi-Fi et Cliquez sur «valider»

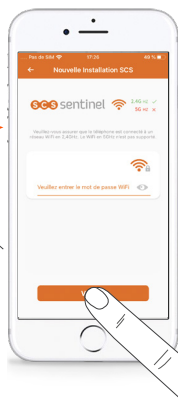

**6** Sélectionnez le module Wi-Fi



**7** Entrez un code PIN à 6 chiffres et cliquez sur «suivant»

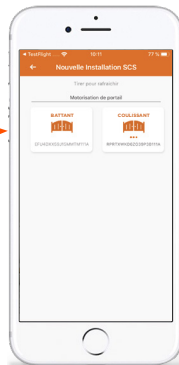

Vous devez impérativement recevoir un signal Wi-Fi près de votre portail pour pouvoir utiliser cette fonction. A défaut, utilisez votre smartphone en mode «hotspot» pendant l'installation.

## D3- Paramétrages et utilisation via smartphone

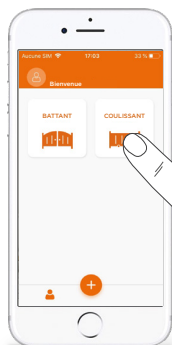

**1** Ouvrir la page de contrôle de la motorisation

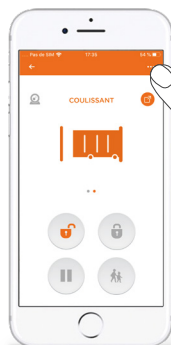

**2** Cliquer sur «...» en haut à droite de l'écran



**3** Sélectionner «réglages des paramètres»

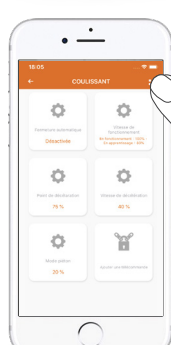

**4** Choisir la fonction à régler. Si elle n'est pas disponible, cliquer sur l'icône  en haut à droite de l'écran

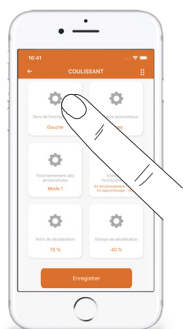

**5** Modifier le/les réglages

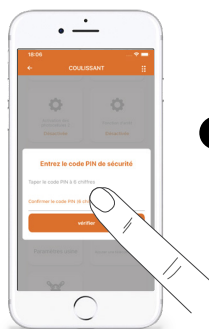

**6** Si besoin, taper le code PIN à 6 chiffres et choisir la fonction à régler

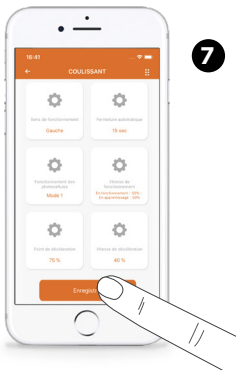

**7** Cliquer sur enregistrer

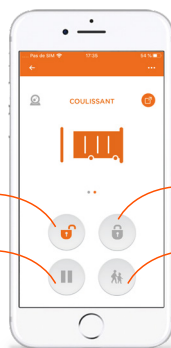

**8** Vous pouvez désormais utiliser votre smartphone pour commander le portail

ouvrir ← → fermer  
 pause ← → ouverture piéton

## D4- Télécommandes

Programmer une télécommande :

Pressez et maintenez 2 secondes la touche «RF-Learn» l'afficheur LED indique «CS». Appuyez ensuite sur n'importe quelle touche de votre télécommande, l'afficheur LED clignote 2 fois puis s'éteint. La programmation de votre télécommande est faite (figure 1,2 et 3)

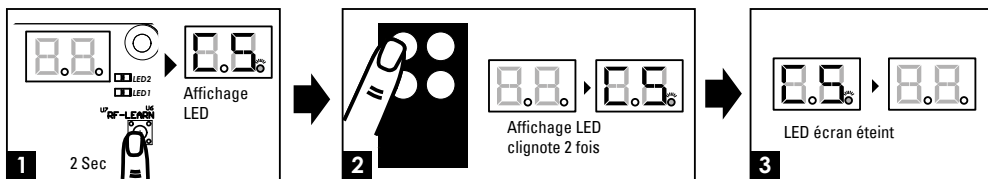

Vous pouvez désormais utiliser votre télécommande comme suit :

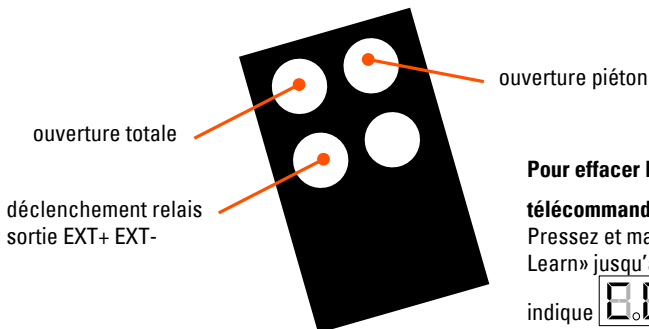

### Pour effacer la mémoire des télécommandes

Pressez et maintenez la touche «RF-Learn» jusqu'à ce que l'afficheur LED indique  (environ 10 s.).

## D5- Système d'apprentissage, re-initialisation et afficheur LED

Attention : avant de procéder à l'apprentissage du système, le processus de mémorisation de la télécommande doit être achevé.

(1) Pour réaliser l'apprentissage du système débrayer votre portail, positionnez-le à la moitié de son ouverture et ré-embrayez-le.

Étape 1 : appuyez sur le bouton « SET », puis sur « SET » + « DOWN » pendant 3 secondes, l'afficheur LED indique « LE » (Figure 1,2 et 3, voir page suivante)

Étape 2 : Appuyez sur le bouton en haut à gauche de votre télécommande pendant 1 à 3 secondes, l'afficheur LED indique alors « LP » (Figure 4 et 5)

Étape 3 : Le portail effectue son auto-apprentissage. C'est-à-dire qu'il se ferme une première fois puis s'ouvre et se referme. Veuillez attendre que ce processus soit complètement achevé.



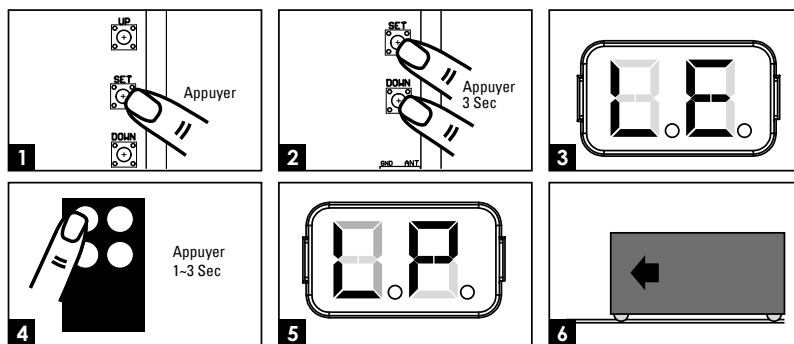

Si votre portail part en ouverture au lancement de la programmation, arrêtez le programme en appuyant sur SET. «L» apparaît sur l'afficheur; attendez qu'il s'éteigne puis allez dans le programme 1 pour inverser le sens de rotation de votre portail (voir page suivante).

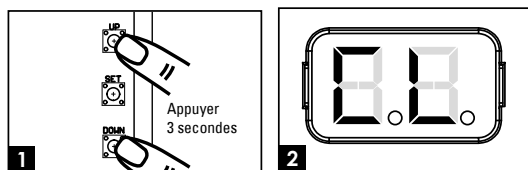

(2) Pour rétablir les paramètres usine

Pressez et maintenez les boutons « UP » et « DOWN » pendant 3 secondes, l'afficheur indique « CL ».



Afficheur LED	Description
	« -L » : le processus d'apprentissage n'est pas terminé.
	« OP » : le système est en fonctionnement normal. Pour entrer dans la programmation, appuyez sur le bouton « SET » pendant 3 secondes. Lorsque l'afficheur LED passe de « OP » à « 1 », appuyez sur les boutons « UP » et « DOWN » pour parcourir les fonctions programmables (1 à P). Appuyez ensuite sur « SET » pour rentrer dans le programme choisi puis appuyez sur « UP » ou « DOWN » pour changer les paramètres de la fonction et « SET » pour valider.
	« LE » : entrée en mode apprentissage, suivez les instructions.
	« LP » : le système d'apprentissage est en cours. Le processus d'auto-apprentissage est le suivant : Ouverture complète > fermeture complète
	« CL » : Réinitialisation avec les paramètres usine

## D6- Réglages des fonctions programmables

Pour entrer dans les réglages, maintenir la touche «SET» 5 secondes. Un «1» s'affiche. Faire défiler avec «UP» ou «DOWN» jusqu'à la fonction désirée, puis «SET» pour entrer dans la fonction. Ensuite, modifier la valeur avec «UP» ou «DOWN» (attention, si aucune touche n'est pressée pendant 5 secondes, l'afficheur sort du mode réglage automatiquement).

Afficheur LED	Définition	Fonction	Valeur	Description
1	Option de direction d'ouverture de portail	1-1	Ouverture à gauche	Cette fonction permet d'ajuster la direction d'ouverture du portail. Le réglage d'usine est « 1-1 ».
		1-2	Ouverture à droite	
2	Fermeture automatique	2-0	Pas de fermeture automatique	Cette fonction permet d'ajuster la fermeture automatique après un temps de pause défini. Le réglage d'usine est « 2-0 » : pas de fermeture automatique. Un appui simultané sur les deux touches du haut de la télécommande (portail ouvert ou fermé) désactivera le mode automatique (confirmation avec 3 clignotements du feu clignotant). Refaire l'opération pour réactiver le mode automatique (confirmation avec 3 clignotements du feu clignotant).
		2-1	5 secondes	
		2-2	15 secondes	
		2-3	30 secondes	
		2-4	45 secondes	
		2-5	60 secondes	
		2-6	80 secondes	
		2-7	120 secondes	
2-8	180 secondes			



3	Réaction des photocellules lors d'une détection d'obstacle	3-1	Voir ci-dessous ↓	Veuillez effectuer ce réglage après celui de H & J. Le réglage d'usine est « 3-1 ».
		3-2		
		3-3		

3.1 : Entrée PH1 active uniquement à la fermeture (réouverture totale en cas de passage durant la fermeture)  
Entrée PH2 active uniquement à l'ouverture (refermeture totale en cas de passage durant l'ouverture)

3.2 : Entrée PH1 active uniquement à la fermeture (réouverture totale en cas de passage durant la fermeture)  
Entrée PH2 active à l'ouverture et à la fermeture (changement de sens pendant 2 secondes si le portail est en mouvement)

3.3 : Entrée PH1 active uniquement à la fermeture (réouverture totale en cas de passage durant la fermeture)  
Entrée PH2 active uniquement à la fermeture (réouverture totale en cas de passage durant la fermeture).  
Portail fermé et arrêté, un passage déclenche l'ouverture (totale)

4	Vitesse du moteur	4-1	Lent	Le réglage d'usine est « 4-3 ».
		4-2	Moyen	
		4-3	Rapide	
		4-4	Très rapide	
5	Réglages de la distance du ralentissement	5-1	75% de la distance complète	Le réglage d'usine est « 5-1 »
		5-2	80%	
		5-3	85%	
		5-4	90%	
		5-5	95%	
6	Vitesse de ralentissement (% de la vitesse maxi)	6-1	80%	Le réglage d'usine est « 6-3 »
		6-2	60%	
		6-3	40%	
		6-4	25%	
7	Force de moteur	7-1	2A	Cette fonction permet d'ajuster la force du moteur par rapport au poids du portail. Le réglage d'usine est « 7-5 ».
		7-2	3A	
		7-3	4A	
		7-4	5A	
		7-5	6A	
		7-6	7A	
8	Ouverture partielle (ouverture piéton)	8-1	10%	Cette fonction permet d'ajuster la largeur de l'ouverture partielle. Le réglage d'usine est « 8-2 ».
		8-2	20%	
		8-3	30%	
		8-4	40%	
		8-5	50%	
		8-6	60%	

9	Clignotement	9-0	Le feu clignote dès que le portail commence à se déplacer.	Le réglage d'usine est « 9-0 ».
		9-1	Le feu clignote 3 secondes avant que le portail commence à se déplacer.	

A	Inversion de sens lors de la rencontre d'un obstacle	A-0	Pas d'inversion	Le réglage d'usine est « A-3 ». La fonction d'inversion fonctionne uniquement 3 fois puis s'arrête. En cas d'inversion de sens, la fonction de fermeture automatique est annulée.
		A-1	Inversion pendant 1 seconde	
		A-2	Inversion pendant 3 secondes	
		A-3	Inversion jusqu'à la fin	
C	Bouton de contrôle pour ouverture totale (sur la télécommande)	C-1	Touche en haut à gauche	Le réglage d'usine est « C-1 ».
		C-2	Touche en haut à droite	
		C-3	Touche en bas à gauche	
		C-4	Touche en bas à droite	
E	Bouton ouverture partielle - passage piéton (sur la télécommande)	E-0	Pas de fonction	Le réglage d'usine est « E-2 ».
		E-1	Touche en haut à gauche	
		E-2	Touche en haut à droite	
		E-3	Touche en bas à gauche	
F	Bouton de contrôle d'un appareil externe (sur la télécommande)	E-4	Touche en bas à droite	Le réglage d'usine est « F-3 ».
		F-0	Pas de fonction	
		F-1	Touche en haut à gauche	
		F-2	Touche en haut à droite	
		F-3	Touche en bas à gauche	
F-4	Touche en bas à droite			

H	Photocellules 1	H-0	Inactives	Le réglage d'usine est « H-0 ».
		H-1	Actives	
J	Photocellules 2	J-0	Inactives	Le réglage d'usine est « J-0 »
		J-1	Actives	
L	Commande de stop	L-0	Ferme	Le réglage d'usine est « L-0 ». sortie 11 et 12
		L-1	Ouvre	
P	Logique de fonctionnement télécommande	P-1	Ferme	Le réglage d'usine est « P-1 »
		P-2	Ouvre	

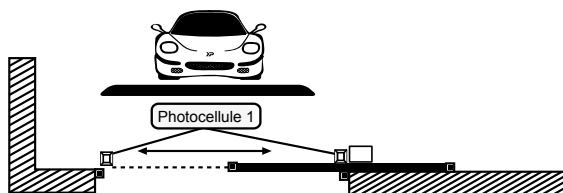

## D7- Essais et vérification



Veuillez soigneusement réaliser les vérifications ci-dessous :

- Débloquez le motoréducteur avec la clé de déverrouillage.
- Assurez-vous que le portail puisse être déplacé manuellement pendant les phases d'ouverture et de fermeture avec une force max 390N (40 kg environ).
- Verrouillez le motoréducteur.
- Utilisez le sélecteur à clé, appuyez sur le bouton ou utilisez l'émetteur, testez l'ouverture, la fermeture et l'arrêt du portail puis assurez-vous que le portail soit dans la bonne direction.
- Vérifiez les appareils un par un (photocellules, feu clignotant, etc.) pour confirmer que l'unité de commande reconnaît chaque appareil.

## D8- Indications voyants LED



LED	Description
LED 1	La LED1 s'allume, lorsqu'il y a un obstacle entre les photocellules ou un défaut d'alignement ou un défaut de branchement (attention, fonction H doit être activée avec une photocellule connectée sur PH1).
LED 2	La LED2 s'allume, lorsqu'il y a un obstacle entre les photocellules ou un défaut d'alignement ou un défaut de branchement (attention, fonction J doit être activée avec une photocellule connectée sur PH2).

## E- CARACTÉRISTIQUES TECHNIQUES

### Télécommandes

Canaux	4
Fréquence - Puissance maximale d'émission	433.92 MHz - puissance < 10 mW
Alimentation	1 pile lithium CR2032 fournie
Sécurité	code secret tournant

## Moteur

Moteur	Moteur 24V DC
Type	coulissant
Régime moteur	2600 tours/min
Poids max du portail/ Largeur max du portail	500 kg / 6 m
Courant de fonctionnement maximum	5.5A pour 10 secondes max.
Température de fonctionnement	-20°C~+50°C
Vitesse	18.56 cm/s

Le niveau de pression acoustique émis pondéré A de la motorisation est égal ou inférieur à 70 dB (A)

## Feu clignotant

Antenne intégrée	OUI (câble coaxial non fourni)
Ampoule	1 ampoule LED (fournie)
Câble alimentation	2 x 1 mm <sup>2</sup> (non fourni)
Branchement	polarisé (carte électronique)
Alimentation	24 V DC
Température de fonctionnement	-20°C~+50°C
Dimensions	74 x 167 x 59 mm

## Photocellules

Méthode de détection	Faisceau infrarouge
Portée	10 m maximum
Tension d'entrée	12~24V AC/DC
Délai de réponse	< 100ms
Indicateur de fonctionnement	RX : LED rouge allumée ( faisceau interrompu) LED rouge éteinte (faisceau aligné) TX : LED rouge allumée (alimentation)
Dimensions	63 x 63 x 30 mm
Type de sortie	Sortie relais

## Crémaillères

Crémaillères	12 x 34 cm
Matériau	nylon renforcé avec insert acier
Longueur fournie	4m (longueur de chaque crémaillère 34 cm)

## Module Wifi

Fréquence de fonctionnement	2412~2472 MHz
Puissance maximale d'émission	9,93 dBm
Normes Wi-Fi	802.11 b/g/n
Température de fonctionnement	- 20° C ~+ 50 ° C

## F- MAINTENANCE

Effectuer les opérations suivantes au moins tous les 6 mois.

En cas d'utilisation fréquente, raccourcir ce délai.

### Couper l'alimentation:

(1) Nettoyer et graisser les vis, les chevilles et la charnière.

(2) Vérifier que les points de fixation soient bien serrés.

(3) Vérifier la bonne connexion de vos câbles.

### Connecter l'alimentation:

(1) Vérifier les réglages de l'alimentation.

(2) Vérifier le fonctionnement du déverrouillage manuel.

(3) Vérifier le bon fonctionnement des photocellules ou autre dispositif de sécurité.

## G- ASSISTANCE TECHNIQUE

### G1- Aide au dépannage

Problème rencontré	Solutions
La porte ne se déplace pas lorsque la télécommande est actionnée	<ol style="list-style-type: none"><li>1. Vérifier si le voltage est supérieur à 22V</li><li>2. Assurez-vous que tous les câblages soient bien connectés sur le bornier</li><li>3. Assurez-vous du bon état du fusible ou du disjoncteur de votre alimentation.</li></ol>
Le portail s'ouvre mais ne se ferme pas	Vérifier si le voyant LED1 est allumé auquel cas vérifier les photocellules, leurs branchements et leur alignement. Repasser le programme H à H-0 pour rendre les photocellules inactives le temps de vérifier vos branchements
Le portail ne fait pas sa course en entier	Augmenter la puissance avec le programme 7 (réglage de 7-1 à 7-6). Mettre à jour les phases de ralentissement avec le programme 6 (réglage de 6-1 à 6-4). Toutefois par journée de grand vent, la motorisation étant tenue à des normes de sécurité anti-pincement et écrasement, des arrêts pourront être constatés (mais ce n'est pas un défaut de matériel)
Les photocellules ne fonctionnent pas	Vérifiez que les photocellules sont activées avec le programme H : H-1. Vérifier que le voyant rouge de la photocellule RX n'est pas allumé. S'il l'est c'est qu'il y a un défaut d'alignement de vos photocellules.
Les télécommandes n'ont pas une bonne portée	Vérifiez la tension de vos piles. Vérifier le branchement de l'antenne et que l'âme unifilaire du câble ne touche pas la tresse.
Le module Wi-Fi ne s'inscrit pas	<ol style="list-style-type: none"><li>1. Assurez-vous que le réseau Wi-Fi est en 2,4 GHz.</li><li>2. Réinitialisez le module Wi-Fi :<ul style="list-style-type: none"><li>- Appuyez pendant 5 secondes sur le bouton P</li><li>- Débranchez et rebranchez le module</li></ul></li></ol>
Si l'ajout du module Wi-Fi échoue	<ul style="list-style-type: none"><li>- Vérifiez que vous êtes bien connecté au Wi-Fi</li><li>- Lorsque vous tapez le mot de passe Wi-Fi, ne pas taper les espaces</li><li>- Vérifiez que vous avez bien saisi le mot de passe Wi-Fi</li><li>- Vérifiez que votre box est bien connectée à internet</li><li>- Vérifiez que votre smartphone est sur le même réseau que celui renseigné dans l'application</li><li>- Vérifiez que l'antenne est bien vissée avant l'installation</li></ul>
Je n'arrive pas à enregistrer le module Wi-Fi dans l'application	Utilisez votre smartphone en mode «Hotspot» si vous manquez de couverture wifi.

Si aucune des procédures de diagnostic ou maintenance ne règle la panne, merci de contacter notre centre technique et hotline.

## G2- Assistance téléphonique

En cas de besoin, vous pouvez prendre contact avec notre assistance technique au numéro ci-dessous. Notre équipe de technicien-nes, basée en France, assure un conseil avisé et personnalisé.



0 892 350 490

Service 0,15 € / min  
+ prix appel

Horaire hotline, voir sur le site internet : [scs-sentinel.com](http://scs-sentinel.com)

### Avant de nous contacter :

- Préparez votre ticket de caisse ou votre facture d'achat ORIGINALE
- Indiquez-nous la référence de votre automatisme
- Munissez-vous de l'outillage nécessaire.
- Ouvrez le caisson pour accéder à la carte électronique (à ne pas faire s'il pleut)
- Placez-vous près de votre automatisme, nos techniciens vous donnent des instructions adaptées à votre cas précis, il est donc indispensable que vous puissiez effectuer en temps réel les manipulations prescrites.

## H- GARANTIE



SCS Sentinel accorde à ce produit une garantie supérieure à la durée légale, en gage de qualité et de fiabilité.

Conservez soigneusement le code-barre ainsi que votre justificatif d'achat, il vous sera demandé pour faire jouer la garantie.

**Il est impératif de garder une preuve d'achat durant toute la période de garantie.**

### Ne sont pas couverts par la garantie :

- Dommages matériels ou électriques résultant d'une mauvaise installation (erreur de câblage, polarité inversée, .. )
- Dommages résultant d'une utilisation impropre (utilisation différente de son origine) ou de modifications.
- Dommages résultant de l'utilisation et/ou installation de pièces ne provenant pas de celles prévues et incluses par SCS Sentinel.
- Dommages dus à un manque d'entretien ou un choc
- Dommages dus aux intempéries telles que : grêle, foudre, vent violent, etc.
- Retours articles sans copie de facture ou justificatif d'achat.

## I- AVERTISSEMENTS



Ne jetez pas les piles et les appareils hors d'usage avec les ordures ménagères. Les substances dangereuses qu'ils sont susceptibles de contenir peuvent nuire à la santé et à l'environnement. Utilisez les moyens de collectes sélectives mis à votre disposition par votre commune ou votre distributeur.

# TABLE OF CONTENTS

---

<b>A - Safety instructions</b> .....	<b>23</b>
<b>B - Description</b> .....	<b>24</b>
B1 - Contents .....	24
B2 - Dimensions.....	24
B3 - Description of device .....	24
<b>C- Wiring / Installing</b> .....	<b>25</b>
C1 - Standard installation.....	25
C2 - Installation of motor gear and gear rack .....	25
C3 - Emergency release .....	28
C4 - Wiring diagram .....	29
C5 - Installing .....	30
<b>D- Setting/Using</b> .....	<b>33</b>
<b>E- Technical features</b> .....	<b>40</b>
<b>F- Maintenance</b> .....	<b>42</b>
<b>G- Technical assistance</b> .....	<b>42</b>
<b>H- Warranty</b> .....	<b>43</b>
<b>I- Warnings</b> .....	<b>43</b>

## A- SAFETY INSTRUCTIONS

---

 **WARNING: Important safety instructions. It is essential to follow these instructions for reasons of personal safety. Keep these instructions in a safe place.**

**WARNING: Important safety instructions. Follow all instructions carefully as improper installation may result in serious injury.**

This product is only designed for the automation of a sliding gate for «residential» use.

The power supply installation must comply with current standards in the country where the product is installed (NF C 15-100 for France) and be carried out by qualified staff.

The mains supply must be protected against overload by a suitable trip switch and an earth leakage circuit breaker.

 **CAUTION:** The motorised system must be disconnected from its power source during cleaning, maintenance and parts replacement.

Installation requires qualified staff with mechanical and electrical skills.

Make sure that the temperature range indicated on the motorised device is suitable for the installation's location. Only original parts should be used to replace or repair the motorised system.

- This appliance may be used by children at least 8 years old and by people with reduced physical, sensory or mental capabilities or without experience or knowledge, if they are properly supervised or instructed in the safe use of the appliance, and if the risks involved have been understood. Children should not play with the appliance. The user's cleaning and maintenance must not be carried out by unsupervised children.

- Do not allow children to play with the unit or its controls, including remote controls.

- Activation of the manual disconnection device may cause uncontrolled movement of the driven part due to mechanical failure or loss of balance.

Before installing the motorised device, check that the driven part is in good mechanical condition, properly balanced and opens and closes correctly.

- The motorised device cannot be used with a driven part incorporating a side gate.

- Ensure that crushing caused by the opening movement of the driven part is avoided between the driven part and the surrounding fixed parts.

- After installation, ensure that the mechanism is properly adjusted and that the protection system and any manual disconnection devices function properly.

- Permanently attach the label for the manual disconnection device to the operating element of this device.

Only use the remote control when you have a complete view of the gate.

If in any doubt, do not operate the system, as it could be damaged.

# B- DESCRIPTION

## B1- Contents

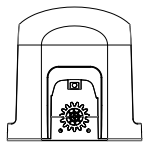

1 motor (electronic card + Wi-Fi module)

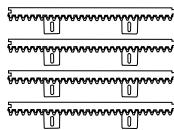

racks (4m)  
AAM0098



2 remote controls  
AAM0050



1 blinker with integrated antenna  
AAM0111

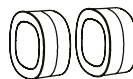

2 photocells  
AAM0036

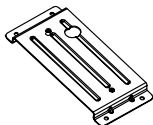

mounting bracket motor



metallic slowing down



screws



lock key



1 manual

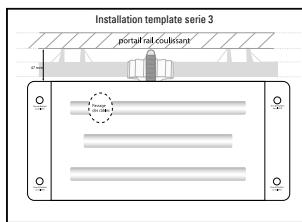

installation template

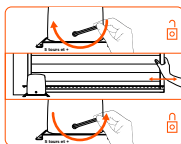

unlocking sticker

## B2- Dimensions

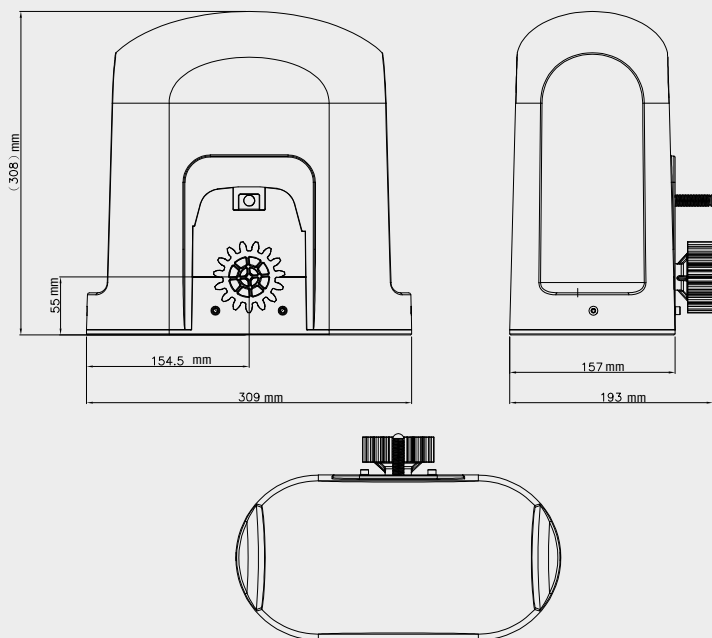



## B3- Description of device

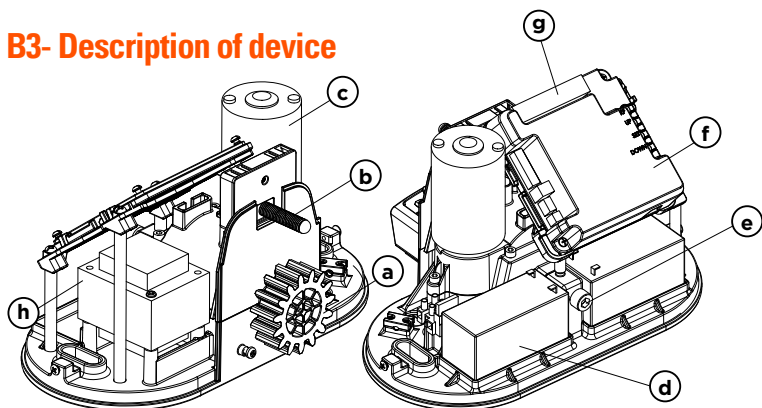

- (a) Operation gear
- (b) Slowing down
- (c) 24V DC motor
- (d) Back-up batteries (option)
- (e) Release device
- (f) Control panel
- (g) Terminal of devices
- (h) 24V AC transformer

## C- WIRING / INSTALLING

### C1- Standard installation

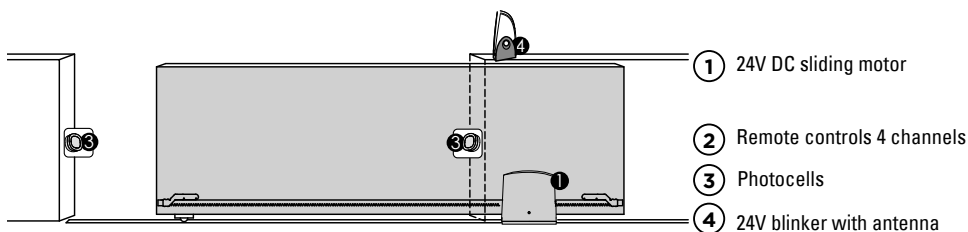

### C2- Installation of motor gear and gear rack

Motorisation must be fixed onto concrete base :

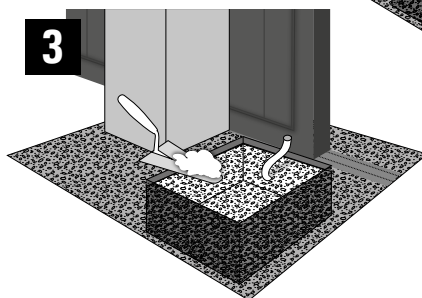
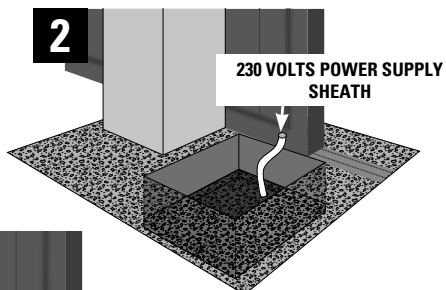
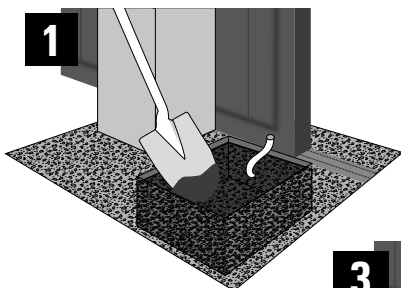

Place the engine support plate to determine the locations of your holes.  
 Engine positioning must be strictly straight vs gate :

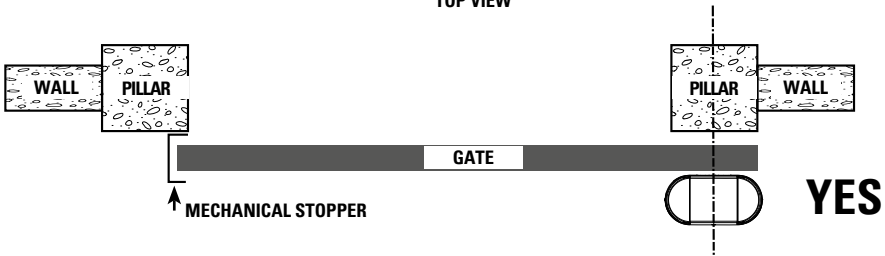
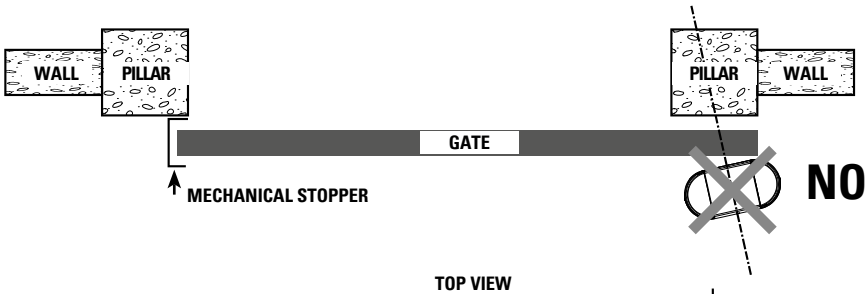
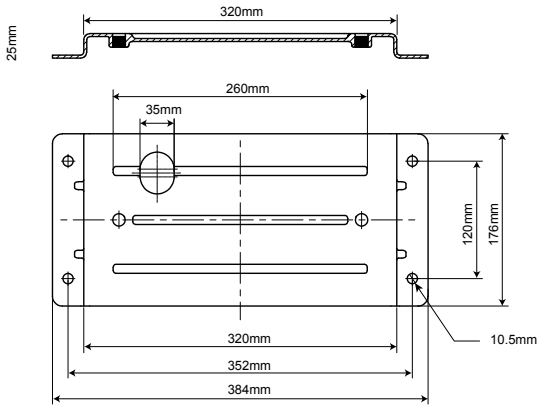

Engine support plate must be fixed at 5 cm from the gate :  
 You can use the delivery template to facilitate the installation.

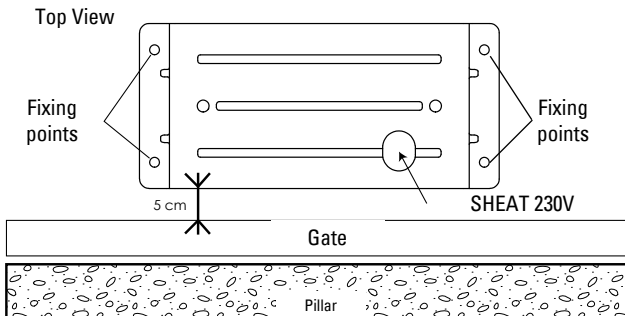

Drill your concrete substrate and install your 4 metal or chemical anchors dowels to secure your engine support plate.

Skip all power cables and accessories.

Make sure using a level tool that the motor mounting plate is level.

Position your engine and bolt it with 2 screws provided.

**Nylon racks fixation :**

Nylon rack are producing by thermoplastic material with steel insert and adapted to the gates of a weight of 500 Kg maximum. They are easily mounted on the portal, by simple screwing. We provide you with the self-drilling screws.

If your portal conception does not allow direct mounting racks, you must create a new support base :

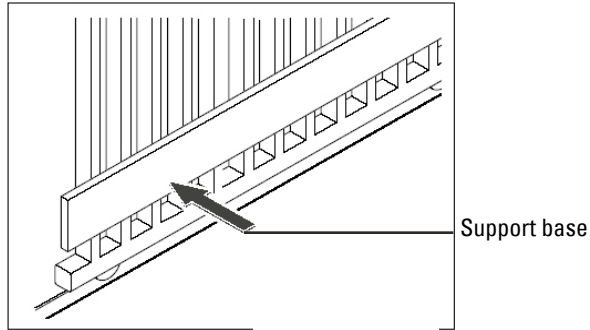

To place the first rack, put it down respecting a 2 mm space between the engine's toothed wheel and the rack as indicated on the scheme below :

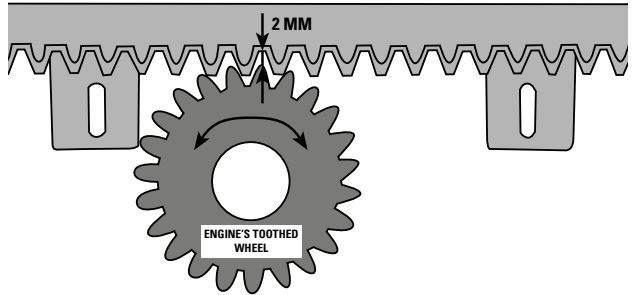

Then draw your markings to screw self-drilling screw as shown below :

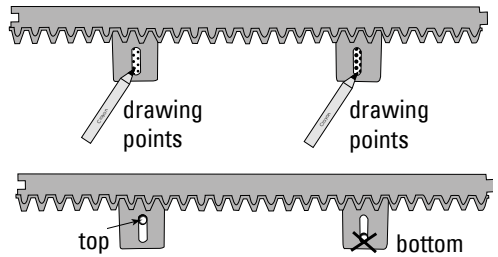
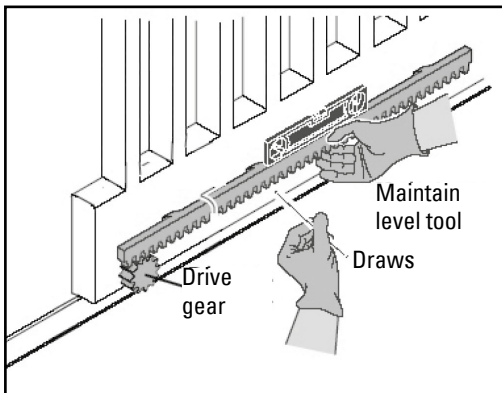

Screw the self-drilling screw up the slot of your rack :

Check that the toothed wheel of your engine covers the entire surface of the rack :

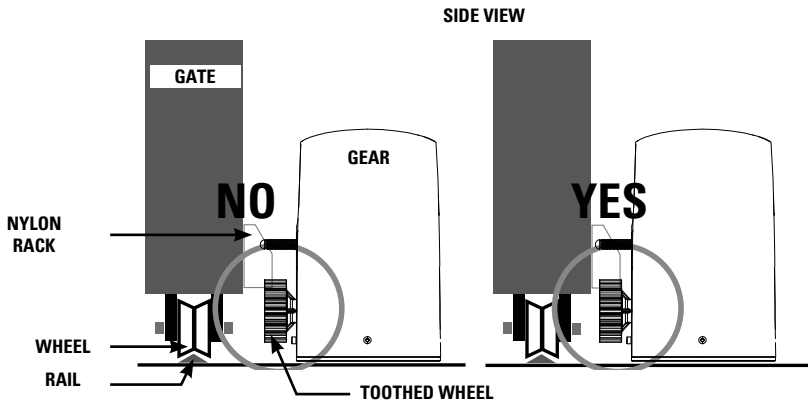

Place the slowing down on the nylon racks

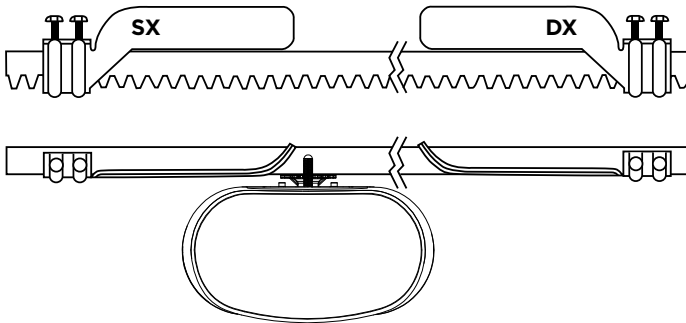

### C3- Emergency release

In case of power switch off or for motorization programming, you can unlock manually your engine: Position yourself inside of the gate.

Insert key tool (inside screw set). Screw it 5 to 10 times. You can remove manually your gate.

For locking you gear, insert key tool (inside screw set) Unscrew it 5 to 10 times to reverse side. Check if your gear is on fixed position.

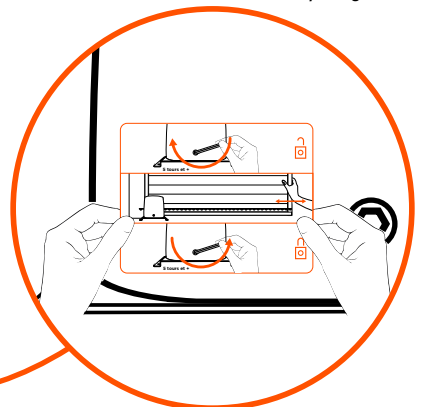
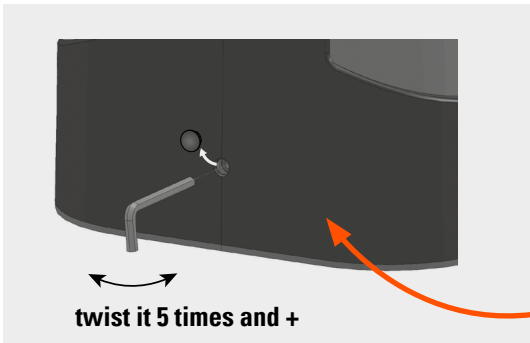

Permanently attach the label for the manual disconnection device to the operating element of this device.

# C4- Wiring diagram

Figure 1

**imperative wiring :**

▲ 0.5 mm<sup>2</sup>

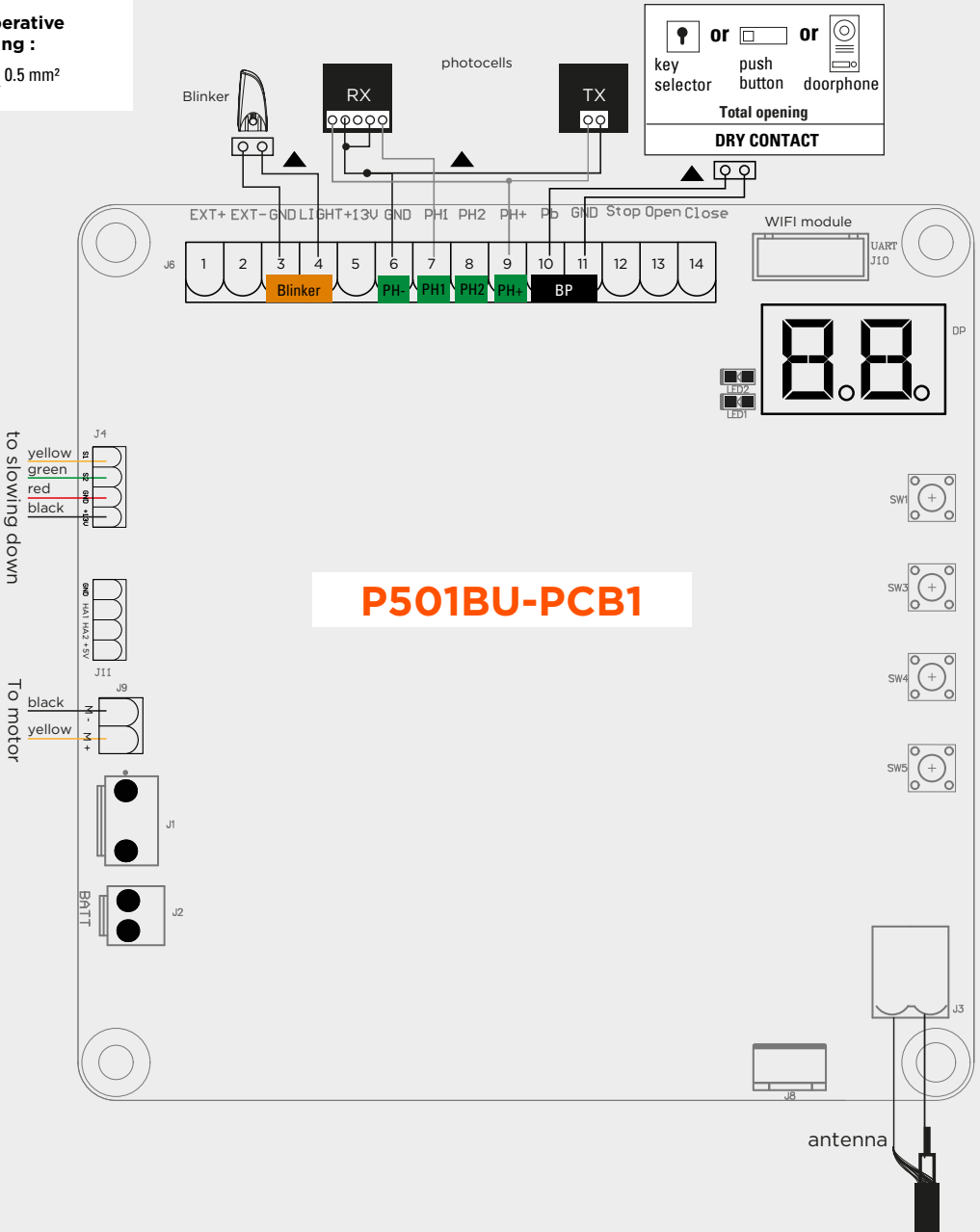

**P501BU-PCB1**

## C5- Installing

### 230V connection switch power supply

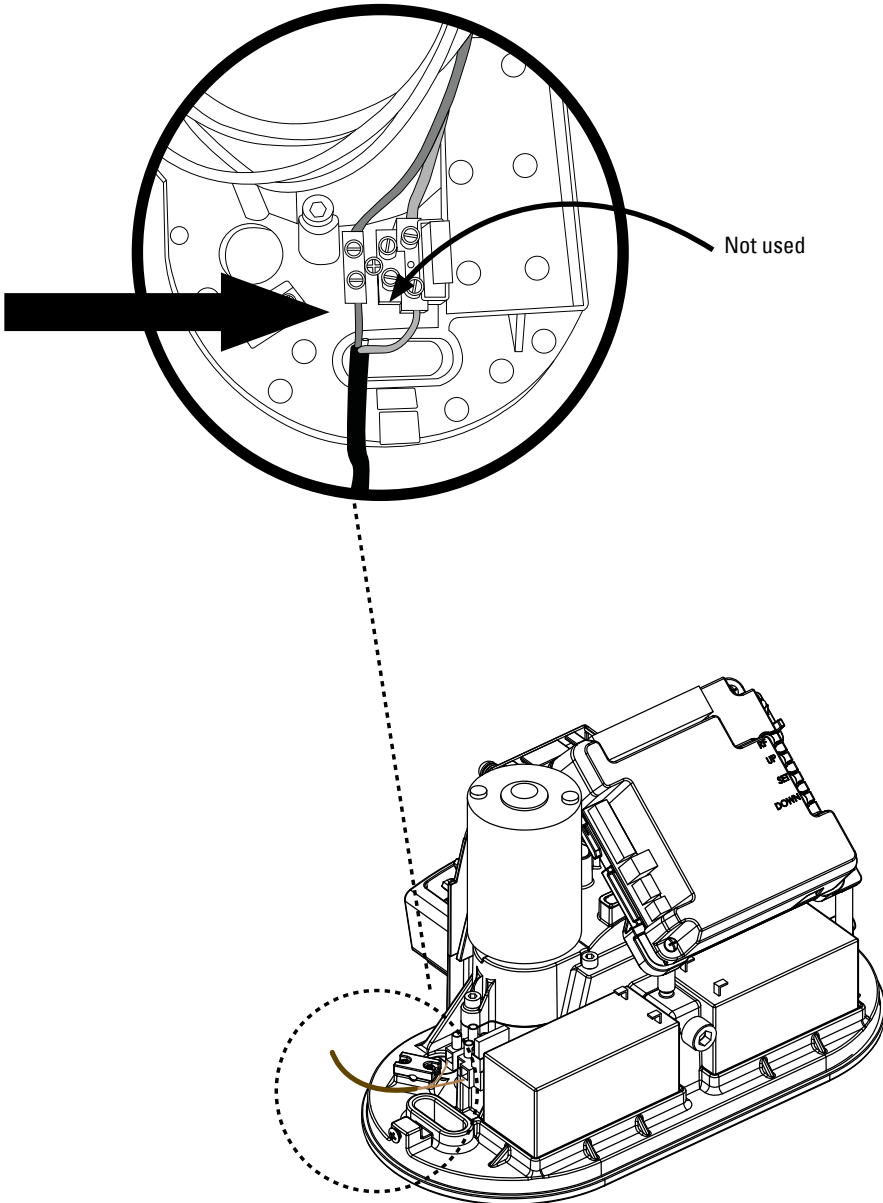

# Blinker

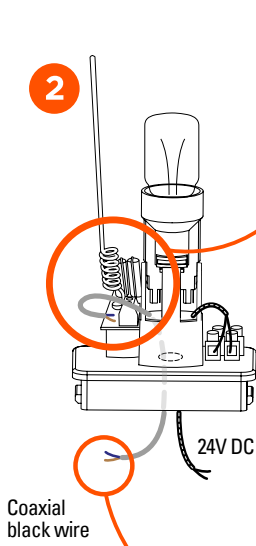
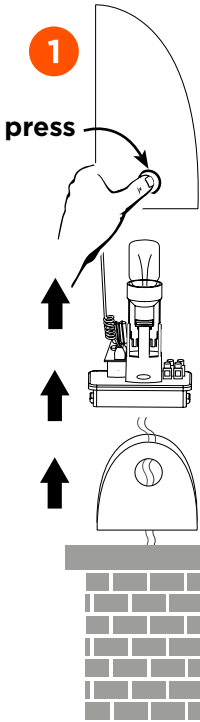

If you want to improve the operating range of your remote, you can connect the blinker antenna with a RG58 coaxial cable (not supplied). In this case you must disconnect the original antenna and then connect the coaxial copper core to the terminal ANT and the coaxial braided shield to the terminal GND on both antenna and electronic card.

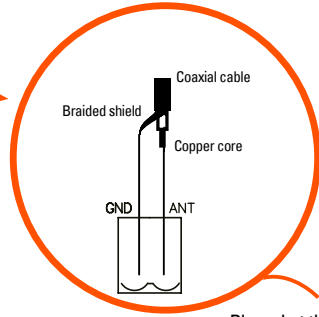

Placed at the bottom right of PCB

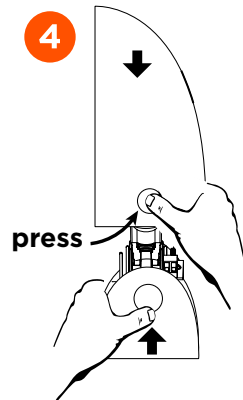
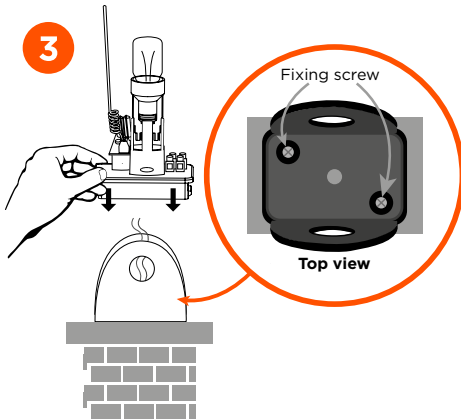

## Photocells

The photocells are safety devices for control automatic gates. Consist of one transmitter and one receiver based in waterproof covers; it is triggered while breaking the path of the beams.

### STEP 1

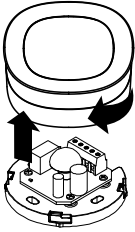

### STEP 2

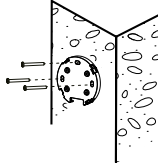

### STEP 3

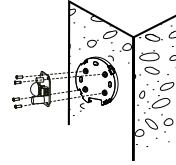

### STEP 4

#### CARD

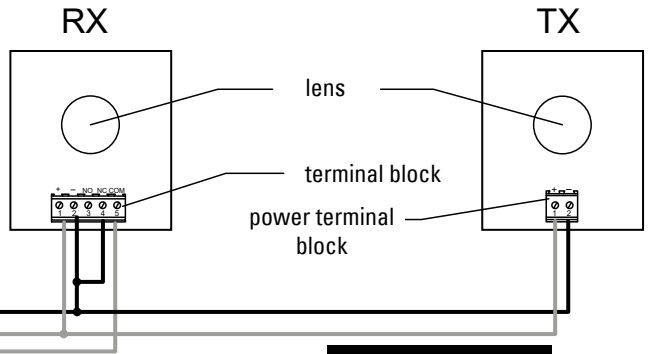
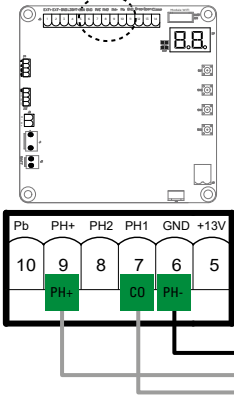

Once the photocells are connected, do not forget to modify the H program and to set H-1: Otherwise, the photocells will have no effects on the motorization (see page 39-40)

### STEP 5

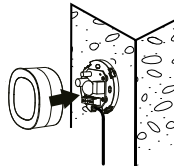

**cable type :**  
0.5 mm<sup>2</sup>

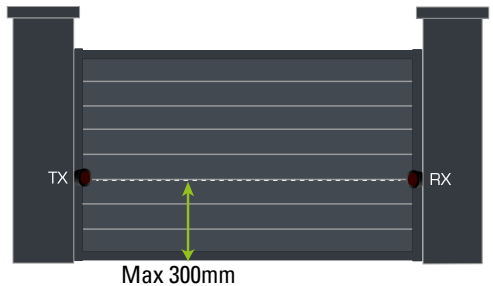

Aligning 

Aligning 



## D- SETTING / USING

The automatism is equipped with a Wi-Fi module that will allow you to use and configure your automatism from your smartphone. You can also make the adjustments in a traditional way. Both adjustments will be differentiated as below :



Traditional settings



Settings via smartphone

### D1- Wi-Fi module

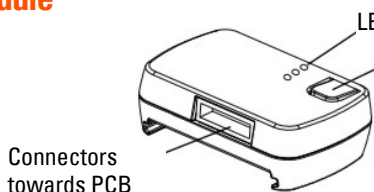

**P button :**

Default settings: press for 5 seconds, unplug and reconnect the wire.

If you need to program the module, press the P button and follow the steps described on D2.

• LED's detail :

Blue : The LED will flash during the Wi-Fi pairing, and will stay lit when pairing is successful.

Green : The LED will flash if the Wi-Fi module will receive a signal from the app.

*If Wi-Fi is off, the green LED will flash continuously and will turn off when Wi-Fi will be connected again.*

Red : Disconnected system or incorrect password

• The Wi-Fi range between the box and the Wi-Fi module is 30 m in free field.



Free-field range

30 m

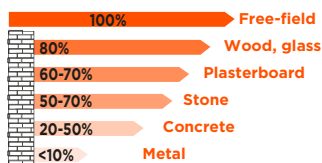

### D2- Automatism and app installation

**1** Download the H'Access app (available on iOS and Android)



H'Access

**2** Register with a password and an ID

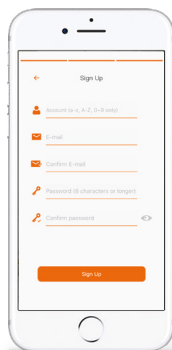

**3** Add your automatism by clicking on

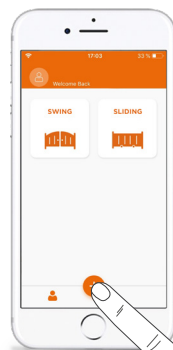

**4** Choose the device to add



**5** Enter your Wi-Fi code and click on «confirm»

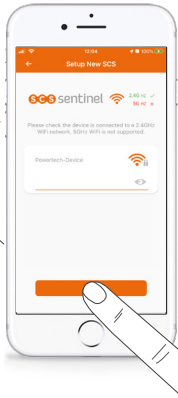

**6** Select the Wi-Fi module

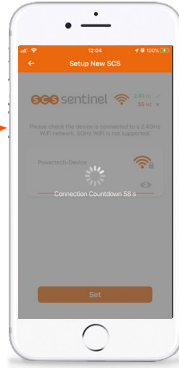

**7** Enter a PIN code (6 numbers) and click on «next»

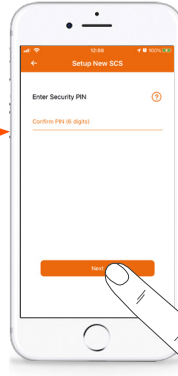
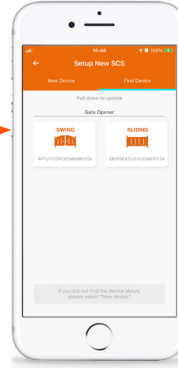

**!** You must receive a Wi-Fi signal next to your gate to be able to use this function. Failure to do so, use your smartphone on «hotspot» mode during the installation.

## D3- Settings and use via smartphone

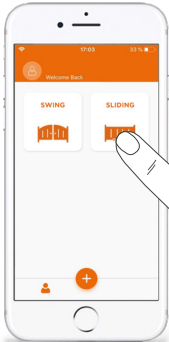

**1** Open the control page of the automatism

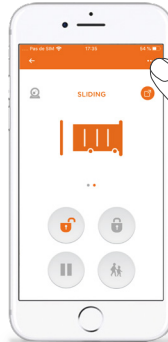

**2** Click on «...» at the right top of the screen

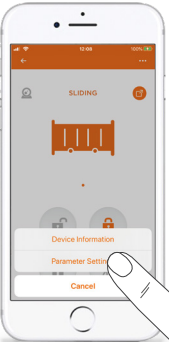

**3** Select «parameter settings»

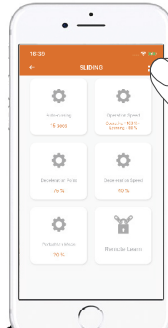

**4** Choose the function to adjust. If it's not available, click on the icon  at the top right of the screen.

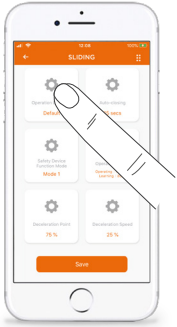

**5** Modify the settings

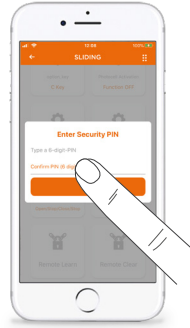

**6** If necessary enter the PIN code (6 numbers) and choose the function to adjust

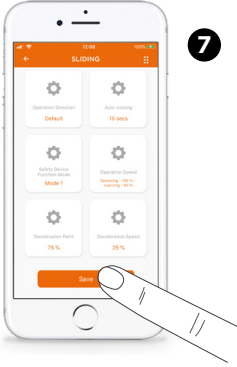

**7** Click on save

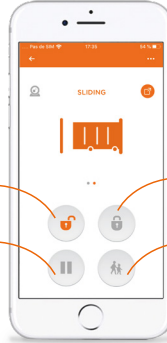

**8** You can now use your smartphone to control the gate

open ← → close  
 pause ← → pedestrian opening

## D4- Remote controls

To program a remote control : Press «RF-Learn» button for 2 seconds, and the LED display shows «CS». Then push any button of the transmitter; the LED flashes twice and then be off. And the remote memory has completed (picture 1,2 et 3)

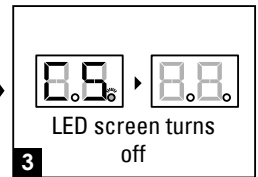
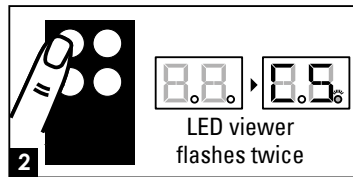
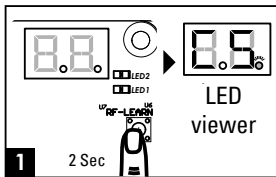

You can now use your remote control as follow :

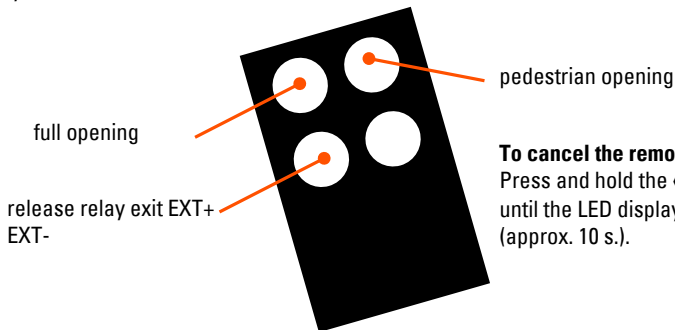

**To cancel the remote controls memory :** Press and hold the «RF-Learn» button until the LED display indicates (approx. 10 s.).

## D5- System learning process, reset process and LED display



**⚠** : The remote control memory storing operation must be over before starting the final system learning process.

(1) To complete the system learning process, disengage your gate and remove it in the middle. Then re-engage it again.

Step 1 : Press the button « SET », then « SET » + « DOWN » during 3 seconds, the LED display shows « LE » (Pictures 1,2 and 3, see following page)

Step 2 : Press the button on the top left of your remote control during 1 to 3 seconds, the LED display shows then « LP » (Pictures 4 and 5)

Step 3 : The gate goes to auto-learning. It means it closes a first time then opens and closes again. Please wait for the learning process to be completed.



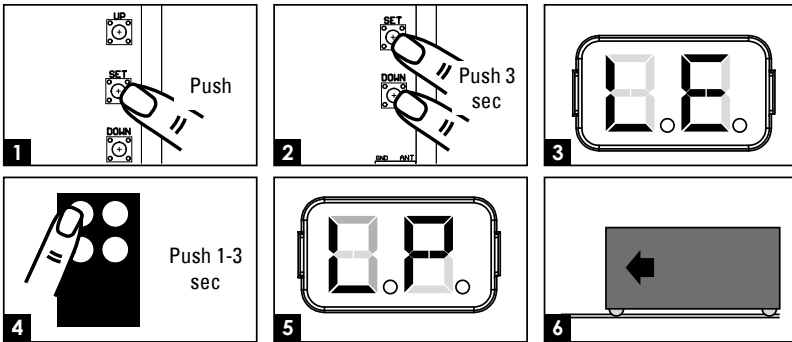

If your gate is opening when you start the programming, stop the program to push on SET. «-L» appears on the display, wait for it to turn off then go on the program 1 to reverse the rotation direction of your gate.

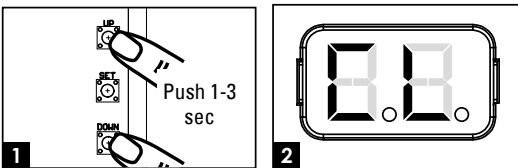

(2) To reset factory settings.

Press UP and DOWN for 3 seconds, and the LED display shows « CL ».



LED Display	Programmable functions
	« -L » : the system learning is not done
	« OP » : the system is in normal operation To program, press SET button for 3 seconds. When the LED display changes from « OP » to « 1 », press UP or DOWN to change the function settings (1 to P). Then press SET to enter the sub function within each group, press UP or DOWN to select sub functions and press SET to valid
	« LE » : Enter the learning mode and then wait for learning instructions.
	« LP » : the system learning is in process. The auto-learning process of gate moving : «Gate open to the end - stop close to the end - stop»
	« CL » : Reset factory setting.

## D6- Programmable function settings

To enter in the settings, maintain the button SET 5 seconds. A «1» appears. Scroll with UP or DOWN until the wanted function, then SET to enter in this function. Then, modify the value with UP or DOWN (Be carefull, if no button is pressed for 5 seconds, the display goes out of the automatic settings mode).

LED viewer	Definition	Function	Value	Description
1	Options of Gate opening direction	1-1	Clockwise opening	The function can adjust the direction of gate opening. The factory setting is « 1-1 ».
		1-2	Counterclockwise opening	
2	Automatic closing	2-0	No automatic closing	This function allows to adjust the gate closing automatic after the paused time. The factory setting is « 2-0 » : no automatic closing. A simultaneous press on the two buttons at the top of the remote control (gate open or closed) will deactivate the automatic mode (confirmation with 3 flashing lights). Repeat the operation to reactivate the automatic mode (confirmation with 3 flashing lights).
		2-1	5 seconds	
		2-2	15 seconds	
		2-3	30 seconds	
		2-4	45 seconds	
		2-5	60 seconds	
		2-6	80 seconds	
		2-7	120 seconds	
2-8	180 seconds			

3	There actions of photocell/ safety edge/ loop detector when they detecting	3-1	See below ↓	Please do the function setting after H&J The factory setting is « 3-1 »
		3-2		
		3-3		
<p>3.1 : Input PH1 active only at closing (total reopening in case of passage during the closing) Input PH2 active only at opening (total reclosing in case of passage during the opening)</p> <p>3.2 : Input PH1 active only at closing (total reopening in case of passage during the closing) Input PH2 active at opening and closing (direction changing during 2 seconds if the gate is moving)</p> <p>3.3 : Input PH1 active only at closing (total reopening in case of passage during the closing) Input PH2 active only at closing (total reopening in case of passage during the closing). Closed and stopped gate, a passage triggers the opening (total)</p>				
4	Motor speed	4-1	Slow	The factory setting is « 4-3 »
		4-2	Middle	
		4-3	Fast	
		4-4	Very fast	
5	The deceleration setting for gate moving	5-1	75% of full distance	The factory setting is « 5-1 »
		5-2	80%	
		5-3	85%	
		5-4	90%	
		5-5	95%	
6	Deceleration speed (% full speed)	6-1	80%	The factory setting is « 6-3 »
		6-2	60%	
		6-3	40%	
		6-4	25%	
7	Force of motor	7-1	2A	The function can adjust the running force of motor to be compatible with the gate weight. The factory setting is « 7-5 »
		7-2	3A	
		7-3	4A	
		7-4	5A	
		7-5	6A	
		7-6	7A	
8	Open partially (pedestrian opening)	8-1	10%	This function can adjust the width of opening partially. The factory setting is « 8-2 »
		8-2	20%	
		8-3	30%	
		8-4	40%	
		8-5	50%	
		8-6	60%	

9	Pre-Flashing	9-0	The flashing light blinks when the gate starts to move	The factory setting is « 9-0 »
		9-1	The flashing light blinks 3 seconds before the gate starts to move	

A	Over current reverse setting	A-0	Stop	The factory setting is « A-3 » . The reverse function only operates 3 times and then stops. If gate reverses, the auto close function will be cancelled.
		A-1	Reverse 1 second	
		A-2	Reverse 3 seconds	
		A-3	Reverse to the end	
C	Full open remote switch (on the remote control)	C-1	the top left button	The factory setting is « C-1 » .
		C-2	the top right button	
		C-3	the bottom left button	
		C-4	the bottom right button	
E	Pedestrian open remote switch (on the remote control)	E-0	No function in transmitter	The factory setting is « E-2 »
		E-1	the top left button	
		E-2	the top right button	
		E-3	the bottom left button	
		E-4	the bottom right button	
F	External device control function key (on the remote control)	F-0	No function in transmitter	The factory setting is « F-3 »
		F-1	the top left button	
		F-2	the top right button	
		F-3	the bottom left button	
		F-4	the bottom right button	
H	Photocells 1 function	H-0	Stand-by	The factory setting is « H-0 »
		H-1	Ready	
J	Photocells 2 function	J-0	Stand-by	The factory setting is « J-0 »
		J-1	Ready	
L	Stop command	L-0	Close	The factory setting is « L-0 » Exit 11 and 12
		L-1	Open	
P	Remote control function	P-1	Close	The factory setting is « P-1 »
		P-2	Open	

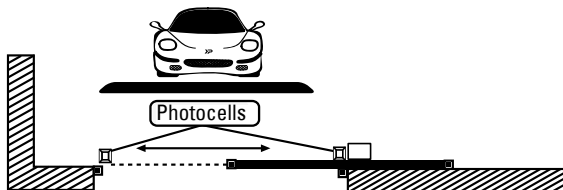

## D7- Testing and checking

Make sure the general safety precaution «WARNING» has been carefully observed :

- Release the gearmotor with the proper release key.
- Make sure the gate can be moved manually during opening and closing phases with a force of max 390N (40 kg approx).
- Lock the gearmotor.
- Using the key selector switch, push button device or the radio transmitter, test the opening, closing and stopping of the gate and make sure the gate is in the intended direction.
- Check the devices one by one (photocells, blinker, key selector, etc.) and confirm the control unit recognizes each device.

## D8- Recognition of LED

LED indications	Descriptions
LED 1 Photocells	The LED1 turns on, when there is an obstacle between the photocells or an aligning defect or a connection defect (Be careful, function H must be activated with a connected photocell on PH1).
LED 2 Photocells	The LED2 turns on, when there is an obstacle between the photocells or an aligning defect or a connection defect (Be careful, function J must be activated with a connected photocell on PH2).

## E- TECHNICAL FEATURES

### Remote controls

Channels	4
Frequency - Maximum transmitted power	433.92 MHz - power < 10mW
Power supply	1 batterie lithium CR2032 included
Security	rolling code technology



## Motor

Motor	motor 24V DC
Gear Type	sliding
Motor Speed	2600 rpm/min
Maximum gate weight/ Maximum gate length	500 kg / 6 m
Maximum operation power	5.5A for 10 seconds max.
Operating temperature	-20°C~+50°C
Speed	23.10 cm/s

The engine-A weighted sound pressure level is 70 dB (A) or less.

## Blinker

Antenna included	YES (coaxial cable not supplied)
Bulb	1 LED Bulb included
Power cable	2 x 1 mm <sup>2</sup> (not included)
Bulb connection	polarized at the electronic card connection.
power supply	24 V DC
Operating temperature	-20°C~+50°C
Dimensions	74 x 167 x 59 mm

## Photocells

Detection Method	infrared beam
Sensing Range	10m max
Input Voltage	AC/DC 12~24V
Response Time	< 100ms
Operation Indicator	RX : Red LED On (beam broken) / Off (beam aligned) TX : Red LED On (power supply)
Dimensions	63 x 63 x 30 mm
Output Method	relay output

## Racks

Racks	12 x 34 cm
Material	nylon with steel insert
Length included	4 m (34 cm for each rack)

## Wifi module

Functioning frequency	2412~2472 MHz
Transmitted max. power	9,93 dBm
Wi-Fi norms	802.11 b/g/n
Operating temperature	- 20° C ~+ 50 ° C

## F- MAINTENANCE

Conduct the following operations at least every 6 months. If in high intensity of use, shorten the period in between.

### Disconnect the power supply:

- (1) Clean and lubricate the screws, the pins, and the hinge with grease.
- (2) Check the fastening points are properly tightened.
- (3) Make the wire connection are in good condition.

### Connect the power supply:

- (1) Check the power adjustments.
- (2) Check the function of the manual release.
- (3) Check the function of photocells or other safety device.

## G- TECHNICAL ASSISTANCE

### G1- Troubleshooting

Problem	Solutions
The gate doesn't move when pressing the button of the transmitter	<ol style="list-style-type: none"><li>1. Check if the power is higher than 22v</li><li>2. Ensure you all the wirings are well connected on the terminal block</li><li>3. Ensure you the good condition of the fuse or circuit breaker of your supply</li></ol>
The gate opens but doesn't close	Check if the LED1 indication is turned on in which case check the photocells, their connections and their aligning. Put the program H-0 for the photocells to be inactive during the check of your connections.
The gate doesn't open entirely	Increase the power with the program 7 (setting from 7-1 to 7-6). Update the phases of slowdown with the program 6 (settings from 6-1 to 6-4). However on windy day, stops can be contested since the automation kit is subjected to anti-pinch and crushing safety norms (but it's not a defect of the device).
The photocells don't work	Check the photocells are activated with the H : H1 program. Check the red LED of the RX photocell is not turned. If it is the case, there is a aligning defect of your photocells.
The remote control is not connected	Check the batteries tension. Check the antenna wiring and that the unifying core of the cable does not touch the braid.
The Wi-Fi module does not fit	<ol style="list-style-type: none"><li>1. Make sure the Wi-Fi network is 2.4 GHz.</li><li>2. Reset the Wi-Fi module :<ul style="list-style-type: none"><li>- Press during 5 seconds on P button</li><li>- Disconnect and reconnect the module</li></ul></li></ol>
If adding the Wi-Fi module fails	<ul style="list-style-type: none"><li>- Check your Wi-Fi connection</li><li>- When typing the Wi-Fi password, do not type spaces</li><li>- Check that you have entered the Wi-Fi password</li><li>- Check that your box is connected to internet</li><li>- Check that your smartphone is on the same network as the one entered in the app</li><li>- Check that the antenna is screwed in before installation</li></ul>
I am unable to register the Wi-Fi module in the app	Use your smatphone with «Hotspot» mode if you lack wifi coverage.

## H- WARRANTY

---



Warranty 3 years

Keep the bar code and your proof of purchase carefully. We'll ask you to activate the warranty.

**The invoice will be required as proof of purchase date.**

### Are never covered by our warranty:

- Damage resulting from the consequences of a bad installation (bad wiring, reverse polarity ...).
- Damage resulting from improper use of the device (use in contradiction with the manual) or its modification.
- Damage resulting from the consequences of the use of components not from SCS SENTINEL.
- Damage due to lack of maintenance, physical shock.
- Damage due to weather: hail, lightning, strong wind etc..
- Returns made without a copy of the invoice or receipt.

## I- WARNINGS

---



Don't throw batteries or out of order products with the household waste (garbage). The dangerous substances that they are likely to include may harm health or the environment. Make your retailer take back these products or use the selective collect of garbage proposed by your city.

<b>A - Istruzioni di sicurezza</b> .....	<b>44</b>
<b>B - Specifiche</b> .....	<b>45</b>
B1 - Contenuto del kit .....	45
B2 - Dimensioni.....	45
B3 - Descrizione de la motorizzazione .....	46
<b>C- Cablaggio / Installazione</b> .....	<b>46</b>
C1 - Installazione dell'automatismo .....	46
C2 - Installazione del motore e delle cremagliere .....	46
C3 - Sblocco di emergenza.....	49
C4 - Schema di cablaggio.....	50
C5 - Impianto.....	51
<b>D- Regolazione / Utilizzo</b> .....	<b>54</b>
<b>E- Caratteristiche tecniche</b> .....	<b>61</b>
<b>F- Manutenzione</b> .....	<b>63</b>
<b>G- Assistenza tecnica</b> .....	<b>63</b>
<b>H- Garanzia</b> .....	<b>64</b>
<b>I- Avvertenze</b> .....	<b>64</b>

## A- ISTRUZIONI DI SICUREZZA

**ATTENZIONE: Importanti istruzioni di sicurezza. Per la sicurezza delle persone è importante seguire queste istruzioni. Conservare queste istruzioni.**

 **ATTENZIONE: Importanti istruzioni di sicurezza. Seguire tutte le istruzioni, un'installazione non corretta può causare gravi lesioni.**

Questo prodotto è destinato esclusivamente all'automazione di un cancello scorrevole per uso di tipo "residenziale".

L'installazione dell'alimentatore deve essere conforme alle norme in vigore nel paese in cui viene installato il prodotto (NF C 15-100 per la Francia) e deve essere effettuata da personale qualificato.

L'alimentazione elettrica di rete deve essere protetta contro le sovratensioni da un adeguato interruttore automatico e da un interruttore differenziale.

 **AVVERTIMENTO** : La motorizzazione deve essere scollegata dalla sua fonte di alimentazione durante la pulizia, la manutenzione e la sostituzione di parti.

L'installazione richiede un personale qualificato con competenze meccaniche ed elettriche.

Assicurarsi che l'intervallo di temperatura indicato sulla motorizzazione sia adatto al luogo di installazione.

Per la sostituzione o la riparazione della motorizzazione, usare solo parti originali.

- Questo dispositivo può essere utilizzato da bambini dagli 8 anni in su e da persone con capacità fisiche, sensoriali o mentali ridotte o senza esperienza o conoscenza, se sono adeguatamente sorvegliati/e, o se sono state date loro istruzioni su come utilizzare il dispositivo in modo sicuro e se i rischi che ne derivano sono stati capiti. I bambini non devono giocare con il dispositivo. La pulizia e la manutenzione a carico dell'utente non devono essere effettuate da bambini senza sorveglianza.

- Non permettere ai bambini di giocare con il dispositivo o con i suoi comandi, compresi i telecomandi.

- L'attivazione del dispositivo di sgancio manuale può causare un movimento incontrollato della parte azionata a causa di un guasto meccanico o di una perdita di equilibrio.

- Prima dell'installazione della motorizzazione, verificare che la parte azionata sia in buone condizioni meccaniche, correttamente bilanciata e che si apra e si chiuda correttamente.

- La motorizzazione non può essere utilizzata con una parte azionata che incorpora una porta pedonale.

- Assicurarsi che venga evitato lo schiacciamento tra la parte azionata e le parti fisse circostanti a causa del movimento di apertura della parte azionata.

- Dopo l'installazione, assicurarsi che il meccanismo sia regolato correttamente e che il sistema di protezione e gli eventuali dispositivi di sgancio manuale funzionino correttamente.

- Applicare in modo permanente l'etichetta per questo dispositivo sull'organo di manovra del dispositivo di sgancio manuale.

Utilizzare il telecomando solo quando si ha una visione completa del cancello.

In caso di dubbio, non azionare mai l'installazione, questo potrebbe danneggiarla.

## B- SPECIFICHE

### B1- Contenuto del kit

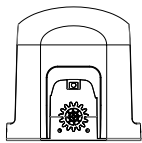

motorizzazione  
(carta elettronica +  
modulo Wi-Fi)

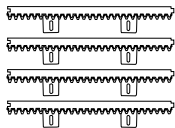

cremagliere (4m)  
AAM0098



2 telecomandi  
AAM0050



1 faro  
lampeggiante  
LED  
AAM0111

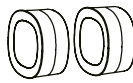

2 fotocellule  
AAM0036

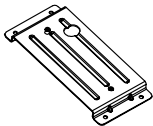

supporto di fissaggio motore



fincorsa metallici



viteria



chiave di blocco



1 manuale

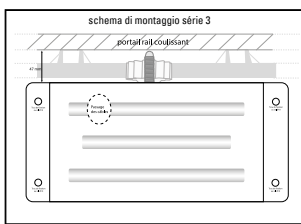

schema di montaggio

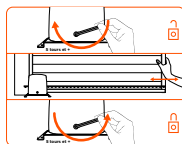

adesivo di sblocco

### B2- Dimensioni

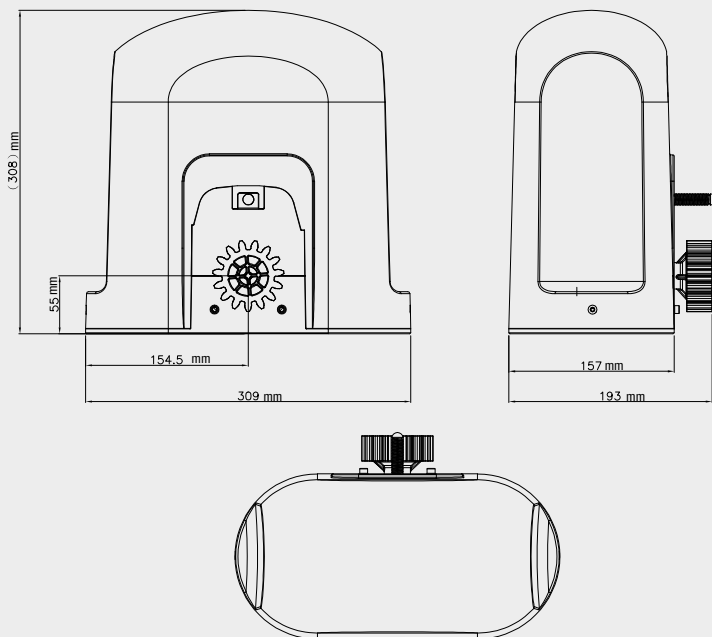

## B3- Descrizione de la motorizzazione

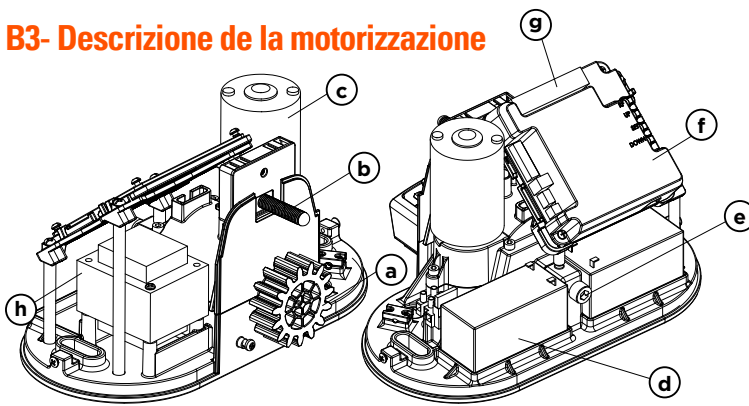

- a** Motoriduttore
- b** Finecorsa metallici
- c** Motore 24V DC
- d** Batterie di emergenza (opzione)
- e** Sblocco
- f** Scheda elettronica
- g** Morsetteria di collegamento
- h** Trasformatore 24V AC

## C- CABLAGGIO / INSTALLAZIONE

### C1- Installazione dell'automatismo

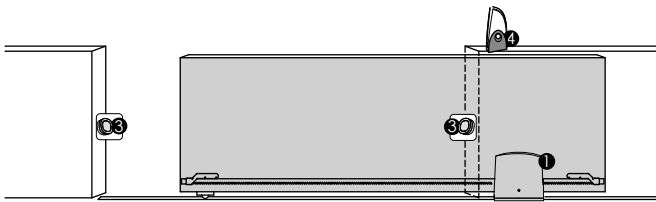

- 1** Motore 24V DC
- 2** Telecomando 4 canaux
- 3** Fotocellule
- 4** Faro lampeggiante 24V con antenna integrata



### C2- Installazione del motore e delle cremagliere

Va privilegiata la posa della vostra motorizzazione su una base in calcestruzzo :

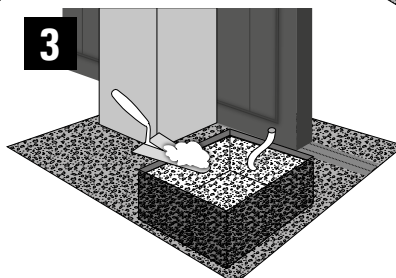
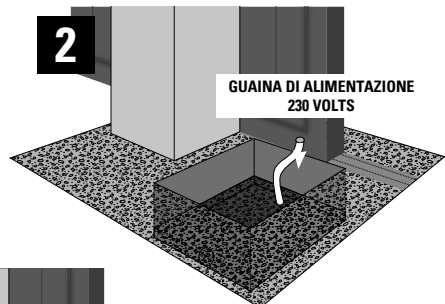
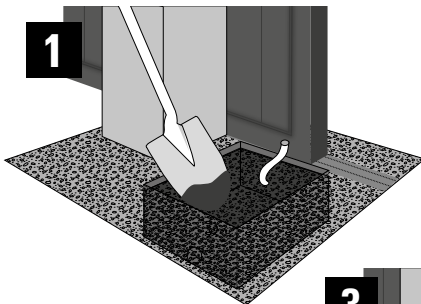

Posizionare la piastra di supporto motore per determinare i posti delle forature.  
 Deve essere perfettamente parallela al cancello :

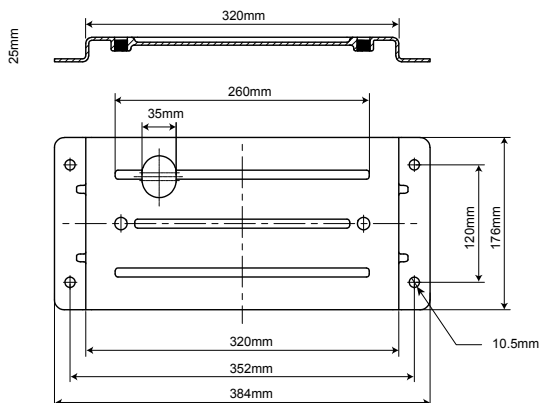

VISTA DA SOPRA



Il bordo della piastra di fissaggio deve trovarsi a 5 cm dal bordo del cancello:  
 Potete utilizzare il schema di montaggio per facilitare l'installazione

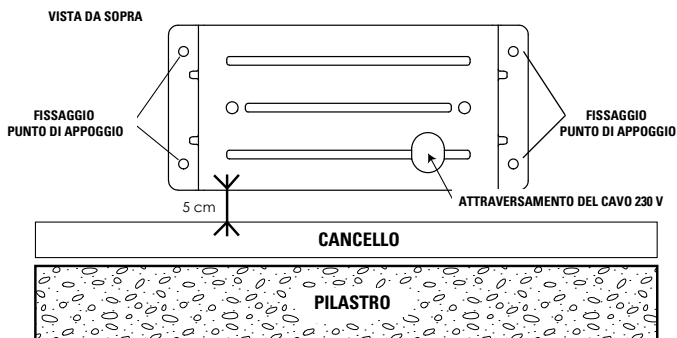

Forare il supporto in calcestruzzo e installare i 4 tasselli meccanici o chimici per fissare la piastra di supporto motore. Passare tutti i cavi di alimentazione e di accessori. Accertatevi usando una livella a bolla che la piastra di fissaggio del motore sia bene livellata. Posizionare il motore e avvitarlo con le due viti fornite.

### Fissaggio della cremagliera:

Le cremagliere fornite, in materiale termoplastico con inserto acciaio sono adatte ai cancelli di un peso di 500 kg. Si montano facilmente sul cancello, con semplice avvitatura. Vi forniamo le viti autoforanti. Se, a causa della sua costruzione, il vostro cancello non autorizza il montaggio diretto delle cremagliere, dovete creare una nuova base di appoggio:

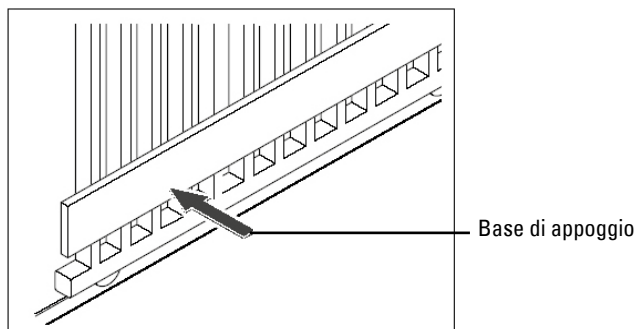

Per posizionare la prima cremagliera, posarla rispettando uno spazio di 2 mm tra la ruota dentata del motore e la cremagliera come indicato sullo schema qui sotto:

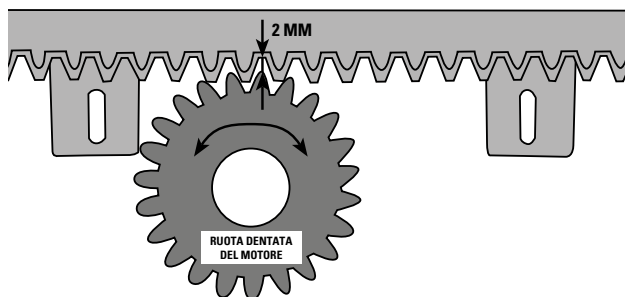

Poi tracciare i vostri segni per avvitare le viti autoforanti come indicato qui sotto:

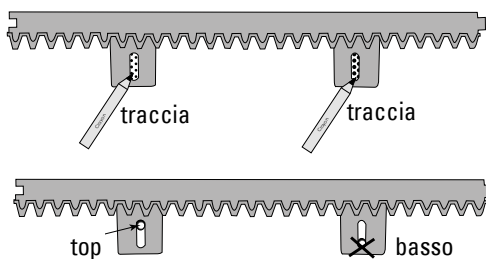
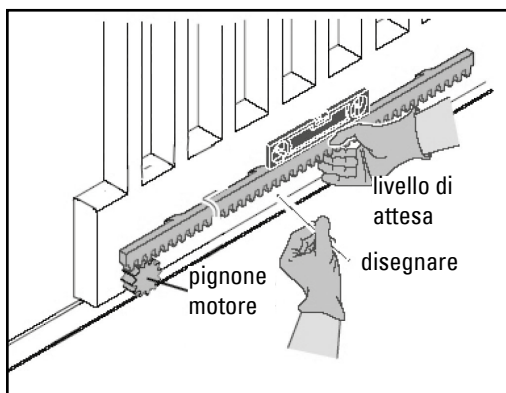

Avvitare la vite autoforante verso l'alto del foro oblungo della cremagliera.



Verificare bene che la ruota dentata del motore occupi tutta la superficie della cremagliera:

#### VISTA DA PROFILO

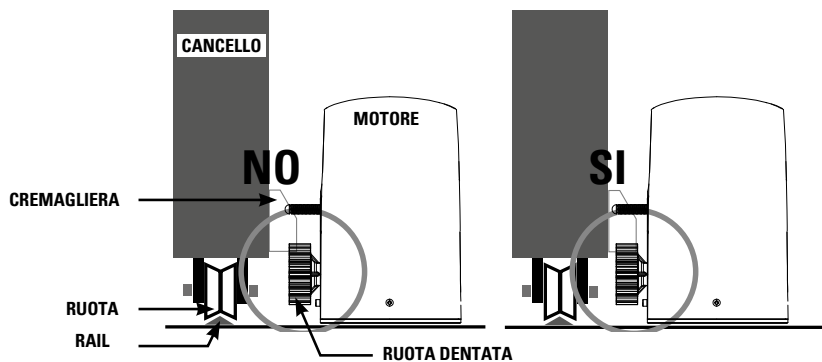

### Posizionare i finecorsa sulla cremagliera

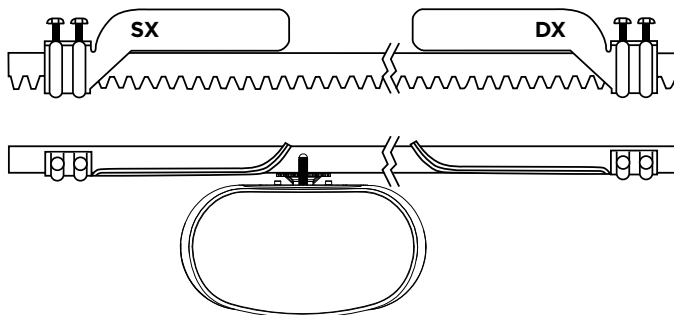

### C3- Sblocco di emergenza

In caso di interruzione di corrente o per programmare il vostro automatismo, potete sbloccare manualmente i motori: Posizionarvi dal lato interno del cancello. Introdurre la chiave a brugola che serve allo sblocco, poi avvitare tra 5 e 10 volte.

Adesso potete aprire il cancello manualmente. Per bloccare di nuovo il motore, introdurre la chiave a brugola che serve allo sblocco, poi svitare tra 5 e 10 volte nell'altro senso.

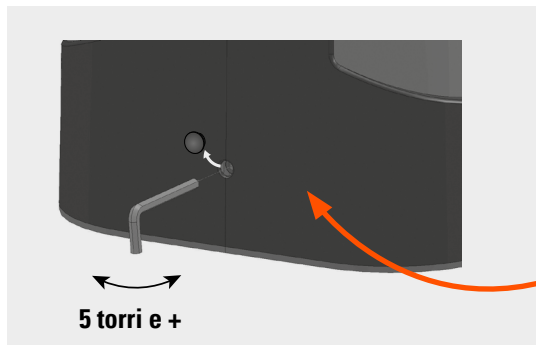

Applicare in modo permanente l'etichetta per questo dispositivo sull'organo di manovra del dispositivo di sgancio manuale. 49  IT

# C4- Schema di cablaggio

Figure 1

cablaggio imperativo :  
▲ 0.5 mm<sup>2</sup>

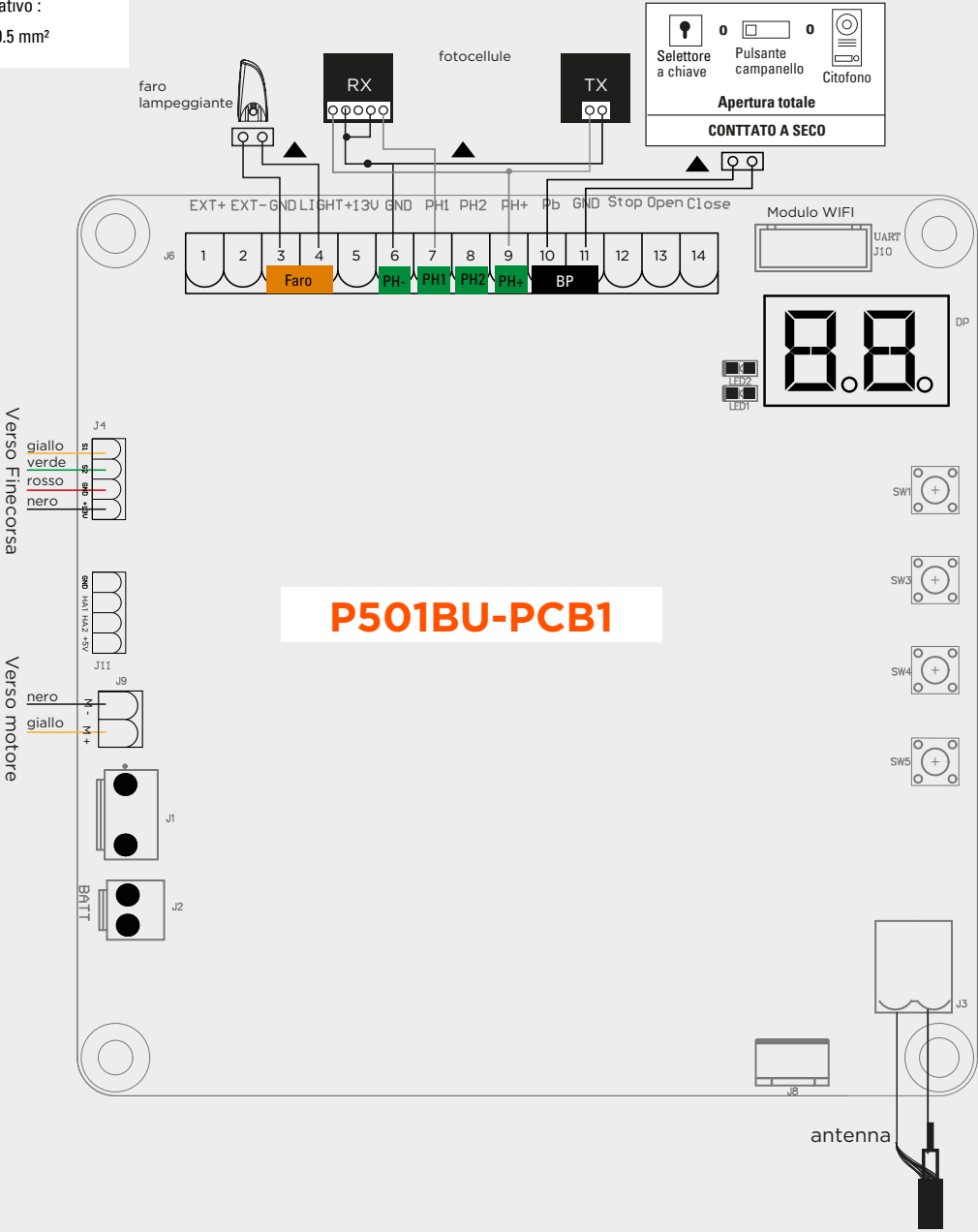

**P501BU-PCB1**

## C5- Impianto

### Collegamento dell'alimentazione 230 volt

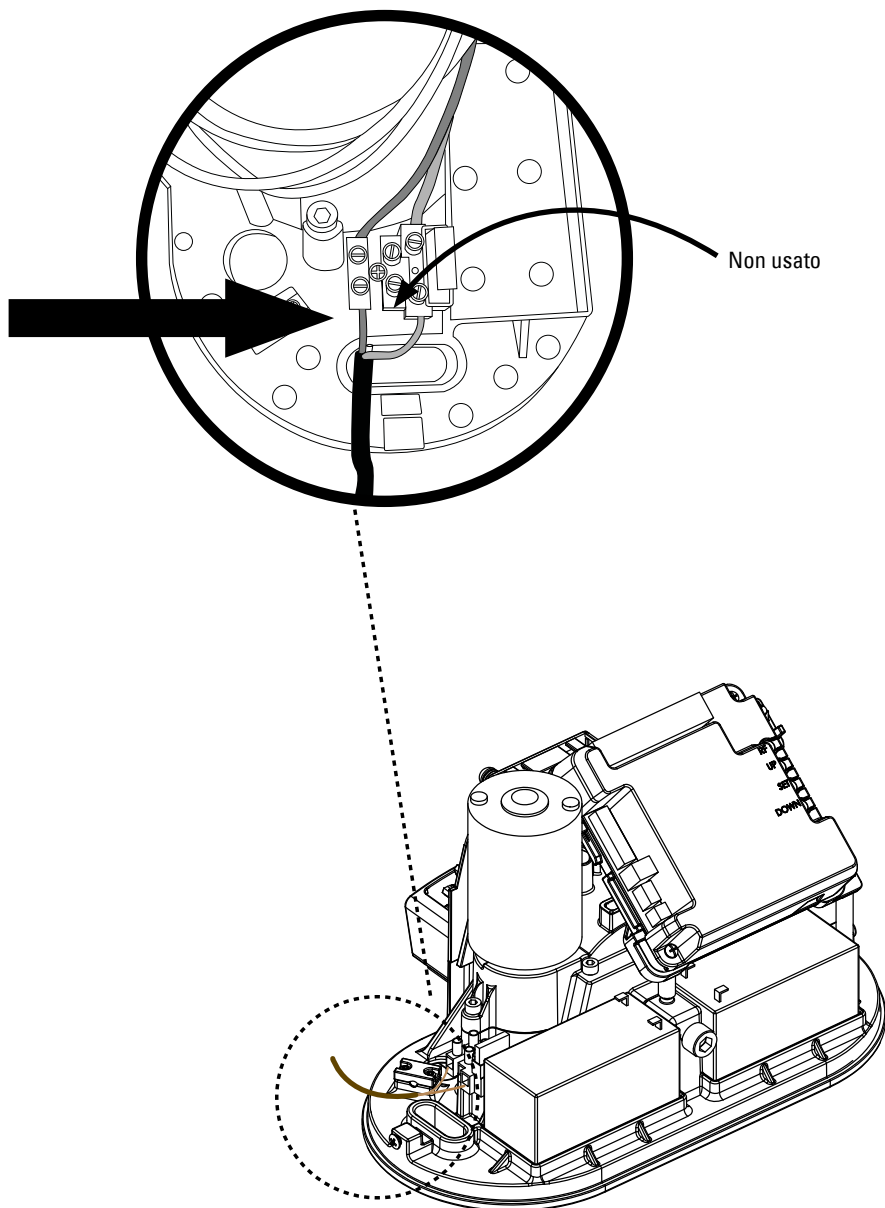

# Faro lampeggiante LED - ref AAM0111

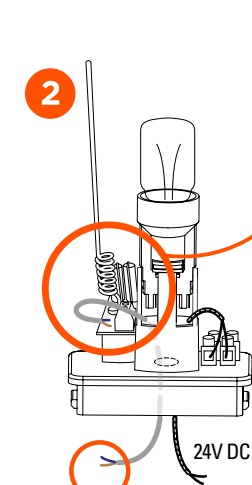
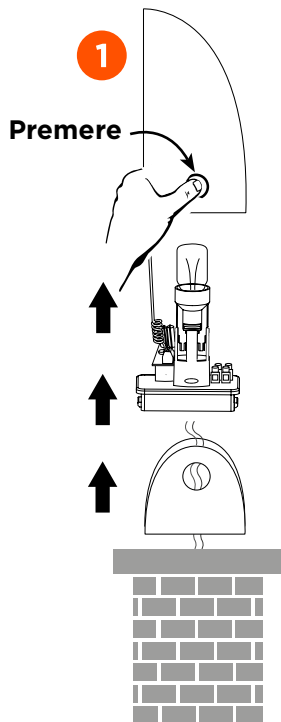

E' possibile aumentare la portata del telecomando collegando l'antenna del lampeggiante con un cavo coassiale RG58 (non fornito). In questo caso, è necessario scollegare l'antenna originale e collegare i nucleo di rame verso la morsettiera ANT e la maglia di rame intrecciata verso la morsettiera GND (antenna e scheda).

cavo coassiale nero

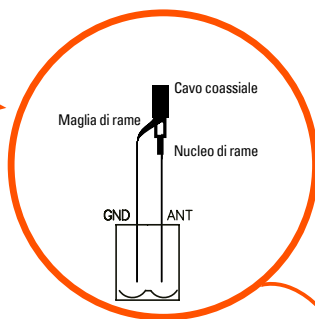

Situato in alto a sinistra del PCB

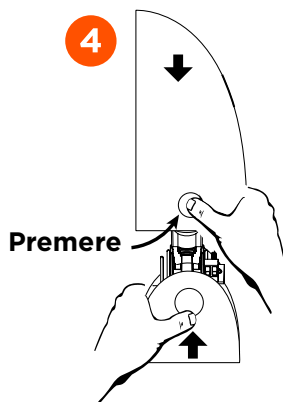
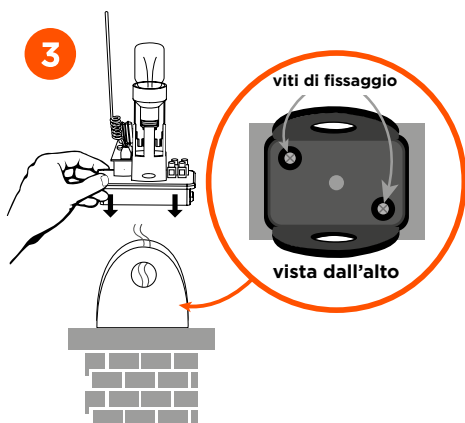

## Fotocellule

Le fotocellule sono dei dispositivi di sicurezza per i cancelli automatici. Sono composte da un emettitore e da un ricevitore e si attivano quando la traiettoria del cablaggio viene interrotta.

### FASE 1

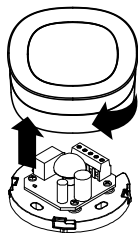

### FASE 2

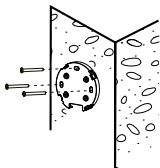

### FASE 3

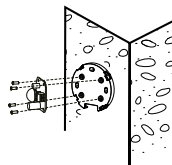

### FASE 4

#### SCHEDA QUADRO

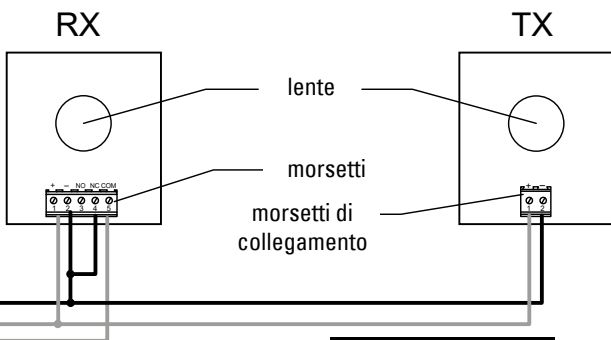
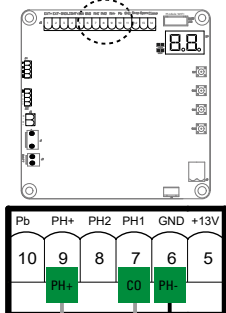

Dopo il collegamento delle vostre fotocellule, non dimenticate di modificare il programma H e regolarlo su H-1 per attivare le vostre fotocellule. Altrimenti, non avranno nessun effetto sul funzionamento della motorizzazione (vedi pagina 61).

### FASE 5

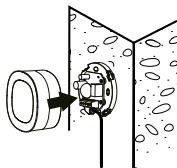

tipo di cavo :  
0.5 mm<sup>2</sup>



Allineamento ✘



Allineamento ✔

## D- REGOLAZIONE/UTILIZZO

La motorizzazione è dotata di un modulo Wi-Fi che vi permetterà di utilizzare e configurare la motorizzazione dal vostro smartphone. Avete anche la possibilità di procedere alle regolazioni in modo tradizionale. I due tipi di regolazione saranno differenziati come di seguito:



Impostazioni tradizionali



Impostazioni tramite smartphone

### D1- Modulo Wi-Fi

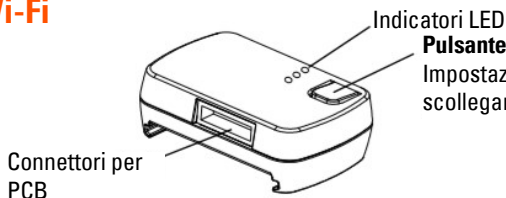

**Pulsante P :**  
Impostazioni predefinite: premere per 5 sec, scollegare e collegare il cavo.

Se si desidera programmare il modulo, premere il pulsante P e seguire le istruzioni di cui al paragrafo D2

• Dettaglio dei LED:

Blu: Il LED lampeggerà durante l'accoppiamento Wi-Fi, e rimarrà acceso quando l'accoppiamento è riuscito.

Verde: Il LED lampeggerà se il modulo Wi-Fi riceve un segnale dall'applicazione.

*Se il Wi-Fi è scollegato, il LED verde lampeggerà continuamente e si spegnerà quando il Wi-Fi sarà nuovamente connesso.*

Rosso: Sistema disconnesso o password Wi-Fi errata.

La portata Wi-Fi tra il box e il modulo Wi-Fi è di 30 metri in campo aperto.



Portata in campo aperto

30 m

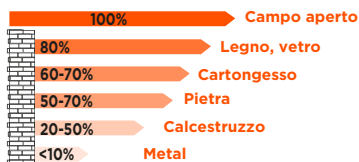

### D2- Installazione dell'app e del dispositivo

**1** Scarica l'applicazione H'Access (disponibile su iOS e Android)



H'Access

**2** Registrati con una password e un nome utente

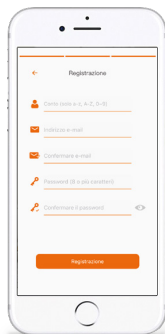

**3** Aggiungere il motore cliccando sul **+**

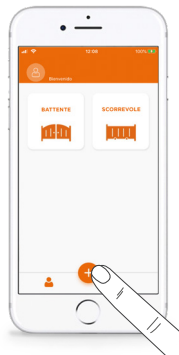

**4** Scegli il dispositivo ad aggiungere

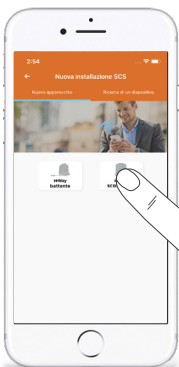

**5** Inserisci il codice Wi-Fi e clicca su «confermare»



**6** Seleziona il modulo Wi-Fi



**7** Immettere un PIN a 6 cifre e fare clic su «Seguente»

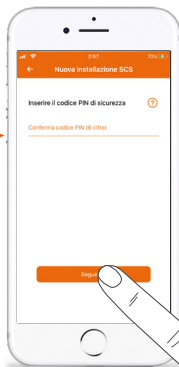
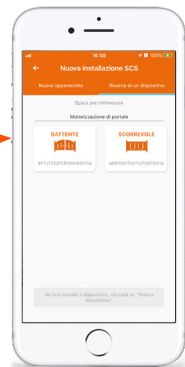

È necessario ricevere un segnale Wi-Fi vicino al portale per poter utilizzare questa funzione. In caso contrario, utilizzare lo smartphone in modo «hotspot» durante l'installazione.

## D3- Impostazioni e utilizzo con smartphone



**1** Apri la pagina di controllo motorizzazione

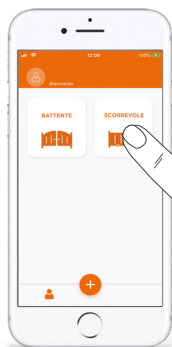

**2** Cliccare su «...» in alto a destra dello schermo

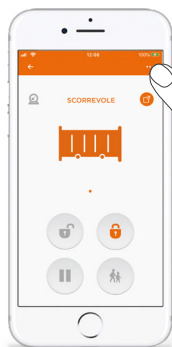

**3** Seleziona «impostazioni dei parametri»



**4** Scegli la funzione da regolare. Se non è disponibile, clicca sull'icona in alto a destra dello schermo

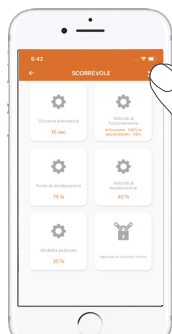

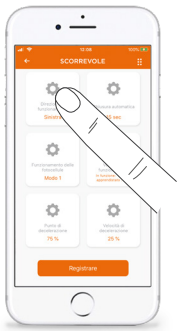

**5** Modifica il/le impostazioni



**6** Se necessario, digitare il PIN a 6 cifre e scegliere la funzione da regolare

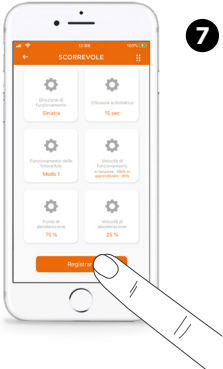

**7** Cliccare su Registrare

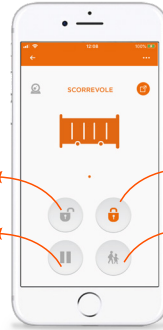

**8** Ora puoi usare il smartphone per controllare il gate

Apri → Chiudi  
pausa → apertura per pedoni

## D4- Telecomandi

Programmare un telecomando. Premere e mantenere premuto 2 secondi il tasto "RF-Learn" il display LED indica "CS". Premere poi su qualsiasi tasto del telecomando, il display LED lampeggia 2 volte poi si spegne. La programmazione del telecomando è eseguita (figura 1, 2 e 3)

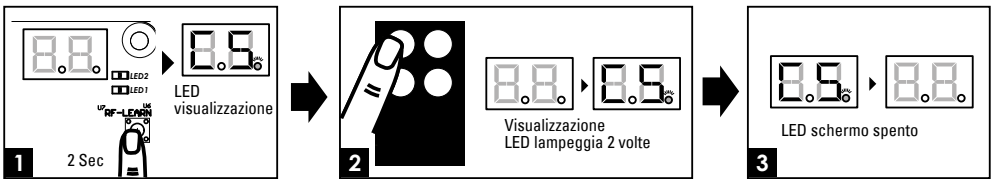

Potete ormai utilizzare il telecomando come segue:



**Per cancellare la memoria dei telecomandi**  
Premere e mantenere premuto il tasto "RF-

Learn" finché il display LED indica  (circa 10 s.).



## D5- Processo di apprendimento, re-inizializzazione e spie LED



**Prima di procedere all'apprendimento del sistema**, il processo di memorizzazione del telecomando deve essere terminato.

(1) Per realizzare l'apprendimento del sistema disinnestare il cancello e posizionarlo alla metà della sua apertura e re-innestarlo.

Tappa 1: premere sul tasto "SET", poi su "SET" + "DOWN" durante 3 secondi, il display LED indica "LE" (Figura 1, 2 e 3, vedi pagina successiva)

Tappa 2: Premere sul pulsante in alto a sinistra del telecomando durante 1 a 3 secondi, il display LED indica allora "LP" (Figura 4 e 5)

Tappa 3: Il cancello effettua l'autoapprendimento. Significa che si chiude una prima volta poi si apre e si richiude. Aspettare che questo processo sia completamente terminato.



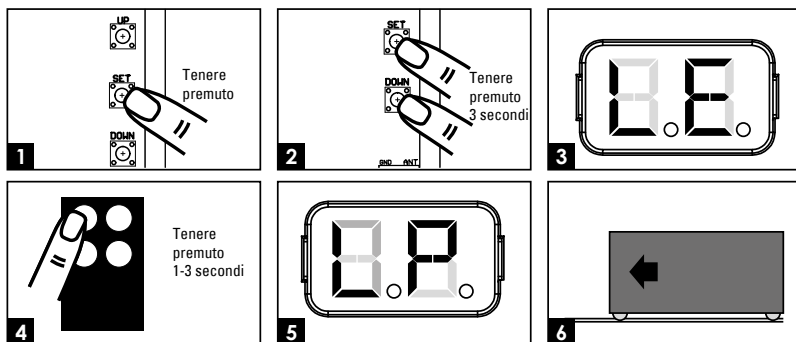

Se il vostro cancello parte in apertura al lancio della programmazione, arrestare il programma premendo su SET, "L" appare sul display, aspettare che si spenga poi andare nel programma 1 per invertire il senso di rotazione del cancello (vedi pagina successiva).

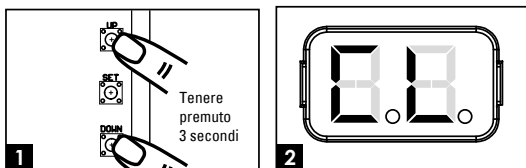

2) Per ripristinare i parametri fabbrica

Premere e mantenere premuto i pulsanti "UP" e "DOWN" durante 3 secondi, il display indica "CL".



Display LED	Descrizione
	"-L": il processo di apprendimento non è terminato.
	"OP": il sistema è in funzionamento normale. Per entrare nella programmazione, premere sul pulsante "SET" durante 3 secondi. Quando il display LED passa da "OP" a "1", premere sui pulsanti "UP" e "DOWN" per esaminare le funzioni programmabili (1 a P). Premere poi su "SET" per entrare nel programma scelto poi premere su "UP" o "DOWN" per cambiare i parametri della funzione e "SET" per convalidare.
	"LE": entrata in modalità apprendimento, seguire le istruzioni.
	"LP": il sistema di apprendimento è in corso. Il processo di autoapprendimento è il seguente: Apertura completa > chiusura completa
	"CL": Reinizializzazione con i parametri fabbrica

## D6- Regolazioni delle funzioni programmabili

Per entrare nelle regolazioni, mantenere premuto il tasto "SET" 5 secondi. Un "1" è visualizzato. Far scorrere con "UP" o "DOWN" fino alla funzione desiderata, poi "SET" per entrare nella funzione. Modificare poi il valore con "UP" o "DOWN" (attenzione, se non è premuto nessun tasto durante 5 secondi, il display esce dalla modalità regolazione automaticamente).

Display LED	Definizione	Funzione	Valore	Descrizione
1	Opzione di direzione di apertura di cancello	1-1	Apertura a sinistra	Questa funzione consente di regolare la direzione di apertura del cancello. La regolazione di fabbrica è "1-1".
		1-2	Apertura a destra	
2	Chiusura automatica	2-0	Nessuna chiusura automatica	Questa funzione consente di regolare la chiusura automatica dopo un tempo di pausa definito. La regolazione di fabbrica è "2-0": nessuna chiusura automatica. Premendo contemporaneamente i due tasti nella parte superiore del telecomando (cancello aperto o chiuso) si disattiva la modalità automatica (conferma con 3 lampeggi della luce lampeggiante). Ripetere l'operazione per riattivare la modalità automatica (conferma con 3 lampeggi della luce lampeggiante).
		2-1	5 secondi	
		2-2	15 secondi	
		2-3	30 secondi	
		2-4	45 secondi	
		2-5	60 secondi	
		2-6	80 secondi	
		2-7	120 secondi	
2-8	180 secondi			

3	Reazione delle fotocellule durante un rilevamento di ostacolo	3-1	Vedere sotto ↓	Effettuare questa regolazione dopo quella di H e J. La regolazione di fabbrica è "3-1".
		3-2		
		3-3		

3.1: Ingresso PH1 attivo solo alla chiusura (riapertura totale in caso di passaggio durante la chiusura)  
Ingresso PH2 attivo solo in apertura (ri-chiusura totale in caso di passaggio durante l'apertura)

3.2: Ingresso PH1 attivo solo alla chiusura (riapertura totale in caso di passaggio durante la chiusura)  
Ingresso PH2 attivo all'apertura e alla chiusura (inversione per 2 secondi se il portale è in movimento)

3.3: Ingresso PH1 attivo solo alla chiusura (riapertura totale in caso di passaggio durante la chiusura)  
Ingresso PH2 attivo solo alla chiusura (riapertura totale in caso di passaggio durante la chiusura)  
Cancello chiuso e chiuso e fermato, un passaggio innesca l'apertura (totale)

4	Velocità del motore	4-1	Lento	La regolazione di fabbrica è "4-3".
		4-2	Medio	
		4-3	Rapido	
		4-4	Molto rapido	
5	Regolazioni della distanza del rallentamento	5-1	Il 75% della distanza completa	La regolazione di fabbrica è "5-1"
		5-2	80%	
		5-3	85%	
		5-4	90%	
		5-5	95%	
6	Velocità di rallentamento (% della velocità max)	6-1	80%	La regolazione di fabbrica è "6-3"
		6-2	60%	
		6-3	40%	
		6-4	25%	
7	Forza del motore	7-1	2A	Questa funzione consente di regolare la forza del motore rispetto al peso del portale. La regolazione di fabbrica è « 7-5 ».
		7-2	3A	
		7-3	4A	
		7-4	5A	
		7-5	6A	
		7-6	7A	
8	Apertura parziale (Apertura pedonale)	8-1	10%	Questa funzione consente di regolare la larghezza dell'apertura parziale. La regolazione di fabbrica è "8-2".
		8-2	20%	
		8-3	30%	
		8-4	40%	
		8-5	50%	
		8-6	60%	

9	Lampeggiamento	9-0	La luce lampeggia non appena il cancello inizia a spostarsi.	La regolazione di fabbrica è "9-0".
		9-1	La luce lampeggia 3 secondi prima che il cancello inizi a spostarsi.	

A	Inversione del senso quando incontra un ostacolo	A-0	Nessuna inversione	La regolazione di fabbrica è "A-3". La funzione d'inversione funziona soltanto 3 volte poi si ferma. In caso di inversione di senso, la funzione di chiusura automatica è cancellata.
		A-1	Inversione durante 1 secondo	
		A-2	Inversione durante 3 secondi	
		A-3	Inversione fino alla fine	
C	Pulsante di controllo per apertura totale (Sul telecomando)	C-1	Tasto in alto a sinistra	La regolazione di fabbrica è "C-1".
		C-2	Tasto in alto a destra	
		C-3	Tasto in basso a sinistra	
		C-4	Tasto in basso a destra	
E	Pulsante apertura Parziale - passaggio pedonale (sul telecomando)	E-0	Nessuna funzione	La regolazione di fabbrica è "E-2".
		E-1	Tasto in alto a sinistra	
		E-2	Tasto in alto a destra	
		E-3	Tasto in basso a sinistra	
		E-4	Tasto in basso a destra	
F	Pulsante di controllo di un apparecchio esterno (sul telecomando)	F-0	Nessuna funzione	La regolazione di fabbrica è "F-3".
		F-1	Tasto in alto a sinistra	
		F-2	Tasto in alto a destra	
		F-3	Tasto in basso a sinistra	
		F-4	Tasto in basso a destra	

H	Fotocellule 1	H-0	Inattive	La regolazione di fabbrica è "H-0".
		H-1	Attive	
J	Fotocellule 2	J-0	Inattive	La regolazione di fabbrica è "J-0"
		J-1	Attive	
L	Comando di stop	L-0	Chiude	La regolazione di fabbrica è "L-0". uscita 11 e 12
		L-1	Aprire	
P	Logique de fonctionnement télécommande	P-1	Chiude	La regolazione di fabbrica è "P-1"
		P-2	Aprire	

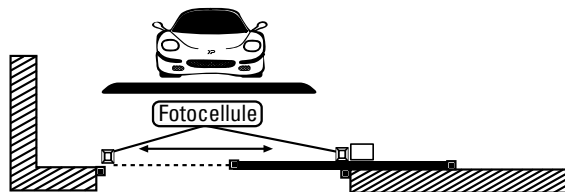

## D7- Prove e verifica

Accertarsi che le precauzioni siano state accuratamente rispettate:

- Sbloccare il motoriduttore con la chiave di sblocco.
- Accertarsi che il cancello possa essere spostato manualmente durante le fasi di apertura e di chiusura con una forza max di 390N (circa 40kg).
- Bloccare il motoriduttore.
- Utilizzare il selettore a chiave, premere sul pulsante o utilizzare l'emettitore, provare l'apertura, la chiusura e l'arresto del cancello poi accertarsi che il cancello sia nella buona direzione.
- Verificare gli apparecchi uno a uno (fotocellule, luce lampeggiante, selettore a chiave, ecc.) per confermare che l'unità di comando riconosce ogni apparecchio.

## D8- Indicazioni spie LED

LED	Descrizione
LED 1	Il LED1 si accende quando c'è un ostacolo tra le fotocellule o un difetto di allineamento o un difetto di collegamento (attenzione, la funzione H deve essere attivata con una fotocellula collegata su PH1).
LED 2	Il LED2 si accende quando c'è un ostacolo tra le fotocellule o un difetto di allineamento o un difetto di collegamento (attenzione, la funzione J deve essere attivata con una fotocellula collegata su PH2).

## E- CARATTERISTICHE TECNICHE

### Telecomandi

Canali	4
Frequenza - Massimi di potenza trasmessa	433.92 MHz - potenza < 10mW
Alimentazione	1 pila litio CR2032 (fornite)
Sicurezza	codice variabile

## Motore

Motore	motore 24V DC
Tipo	a martinetto
Regime motore	2600 torri/min
Peso max. per anta/ Larghezza max. per anta	500 kg / 6 m
Corrente di funzionamento massimo	5.5A per 10 secondi max.
Temperatura di funzionamento	-20°C~+50°C
Velocità	23.10 cm/s

Il livello di pressione sonora emesso ponderato A del motore è uguale o inferiore a 70 dB (A)

## Luce lampeggiante

Antenna integrata	Sì (cavo coassiale non fornito)
Lampadina	1 lampadina LED (fornita)
Cavo de alimentazione	2 x 1 mm <sup>2</sup> (non forniti)
Collegamento lampadina	polarizzato (scheda elettronica)
Alimentazione	24 V DC
Temperatura di esercizio	-20°C~+50°C
Dimensioni	74 x 167 x 59 mm

## Fotocellule

Metodo di rilevamento	cablaggio infrarossi
Portata	10m maximum
Tensione di ingresso	AC/DC 12~24V
Tempo di risposta	< 100ms
Indicatore di funzionamento	RX : LED rosso acceso (cablaggio interrotto) LED rosso spento (cablaggio allineato) TX : LED rosso acceso (alimentazione)
Dimensioni	63 x 63 x 30 mm
Tipo di uscita	uscita relè

## Crema gliere

Crema gliere	12x34 cm
Materiale	nylon rinforzato con inserto in acciaio
Lunghezza fornite	4m (34 cm per ogni crema gliere)

## Modulo Wifi

Frequenza di funzionamento	2412~2472 MHz
Potenza massima di emissione	9,93 dBm
Norme Wi-Fi	802.11 b/g/n
Temperatura di funzionamento	- 20° C ~+ 50 ° C

## F- MANUTENZIONE

Effettuate le operazioni seguenti almeno ogni 6 mesi. In caso di utilizzo frequente, riducete questo intervallo di tempo.

### Interrompete l'alimentazione:

- (1) Pulite e lubrificate le viti, i tasselli e la cerniera.
- (2) Verificate che i punti di fissaggio siano serrati correttamente.
- (3) Verificate il collegamento corretto dei vostri cavi.

### Collegate l'alimentazione:

- (1) Verificate le regolazioni dell'alimentazione.
- (2) Verificate il funzionamento dello sblocco manuale.
- (3) Verificate il corretto funzionamento delle fotocellule o degli altri dispositivi di sicurezza.

## G- ASSISTENZA TECNICA

### G1- Aiuto per la riparazione dei guasti

Problema riscontrato	Soluzioni
La porta non si sposta quando il telecomando viene azionato	<ol style="list-style-type: none"><li>1. Verificate che il voltaggio sia superiore a 22 V</li><li>2. Assicuratevi che tutti i cablaggi siano collegati correttamente sulla morsetteria</li><li>3. Verificate che il fusibile e il disgiuntore della vostra alimentazione siano in buone condizioni.</li></ol>
Il cancello si apre ma non si chiude	Verificare se la spia LED1 è accesa in quel caso verificare le fotocellule, i loro collegamenti e il loro allineamento. Ripassare il programma H a H-0 per rendere le fotocellule inattive il tempo di verificare i vostri collegamenti
Il cancello non fa la sua corsa per intero	Aumentare la potenza con il programma 7 (regolazione da 7-1 a 7-6). Aggiornare le fasi di rallentamento con il programma 6 (regolazione da 6-1 a 6-4). Tuttavia con vento forte, la motorizzazione essendo tenuta a norme di sicurezza anti-pizzicamento e schiacciamento, si potranno verificare arresti (ma non è un difetto del materiale)
Le fotocellule non funzionano	Verificare che le fotocellule siano attivate con il programma H: H-1 Verificare che la spia rossa della fotocellula RX non sia accesa. Se lo è significa che c'è un difetto di allineamento delle vostre fotocellule.
I telecomandi non hanno una buona portata	Verificare la tensione delle vostre pile. Verificare il collegamento dell'antenna e che l'anima unifilare del cavo non tocchi la treccia.
Il modulo Wi-Fi non si registra	<ol style="list-style-type: none"><li>1. Assicurarsi che la rete Wi-Fi è in 2,4 Ghz.</li><li>2. Reimposta il modulo Wi-Fi:<ul style="list-style-type: none"><li>- Premere il pulsante P per 5 secondi</li><li>- Scollegare e ricollegare il modulo</li></ul></li></ol>
Se l'aggiunta del modello Wi-Fi non riesce	<ul style="list-style-type: none"><li>- Verifica di essere connesso al Wi-Fi</li><li>- Quando si digita la password Wi-Fi, non digitare gli spazi</li><li>- Verifica di aver inserito la password Wi-Fi</li><li>- Verifica che il box sia collegato a internet</li><li>- Verifica che il smartphone sia sulla stessa rete indicata nell'app</li><li>- Assicurarsi che l'antenna sia ben avvitata prima dell'installazione</li></ul>
Non riesco a registrare il modulo Wi-Fi nell'app	Utilizzate il vostro smartphone in modalità «hotspot» se vi manca la copertura wifi.

Se nessuna delle procedure di diagnosi o manutenzione risolve l'anomalia, vi preghiamo di contattare il nostro centro tecnico e la nostra hotline.

## G2- Assistenza telefonica

I tecnici del servizio post-vendita sono disponibili al numero :



Hotline



011-2339876

In caso di allungamento del prodotto durante l'installazione o pochi giorni dopo la stessa si invita a contattare il servizio clienti rimanendo in prossimità del prodotto in modo da consentire ai nostri tecnici di diagnosticare subito l'origine del problema.

## H- GARANZIA



Garanzia 3 anni

SCS Sentinel concede a questo prodotto una garanzia superiore alla durata legale, in garanzia di qualità e affidabilità.

**È obbligatorio conservare una prova d'acquisto per tutta la durata della garanzia.** Conservare accuratamente sia il codice a barre che lo scontrino : vi saranno richiesti per far valere la garanzia.

### Non sono coperti dalla garanzia:

- Danni materiali o elettrici derivanti da un'installazione scorretta (errore di cablaggio, polarità invertita, ecc. )
- Danni derivanti da un utilizzo improprio del faro lampeggiante (utilizzo diverso da quello originale) o da eventuali modifiche.
- Danni derivanti dall'utilizzo e/o installazione di pezzi diversi da quelli previsti e inclusi da SCS Sentinel.
- Danni dovuti a una mancanza di manutenzione o a un urto.
- Danni dovuti alle intemperie, come: Grandine, fulmine, vento violento, ecc.
- Resi di articoli senza copia della fattura o della ricevuta di acquisto.

## I- AVVERTENZE



Non gettare le pile e gli apparecchi fuori uso insieme ai normali rifiuti domestici. Potrebbero contenere sostanze pericolose capaci di nuocere alla salute e all'ambiente. Utilizzare i mezzi per la raccolta differenziata messi a disposizione dal comune o dal proprio distributore.



# SUMARIO

<b>A - Instrucciones de seguridad</b> .....	<b>65</b>
<b>B - Descripción</b> .....	<b>66</b>
B1 - Contenido del kit .....	66
B2 - Dimensiones .....	66
B3 - Descripciones del automatismo .....	67
<b>C- Cables / Instalación</b> .....	<b>67</b>
C1 - Instalación del automatismo .....	67
C2 - Instalación del motor et de las cremalleras .....	67
C3 - Desbloqueo manual .....	70
C4 - Esquema de cables .....	71
C5 - Instalación y conexión .....	72
<b>D- Ajuste / Uso</b> .....	<b>75</b>
<b>E- Características técnicas</b> .....	<b>82</b>
<b>F- Mantenimiento</b> .....	<b>84</b>
<b>G- Asistencia técnica</b> .....	<b>84</b>
<b>H- Garantía</b> .....	<b>85</b>
<b>I- Advertencia</b> .....	<b>85</b>

## A- INSTRUCCIONES DE SEGURIDAD

**⚠ ADVERTENCIA: Instrucciones importantes de seguridad. Es importante seguir estas instrucciones para la seguridad personal. Conservar estas instrucciones.**

**ADVERTENCIA: Instrucciones importantes de seguridad. Es importante seguir todas las instrucciones, ya que una instalación incorrecta podría provocar lesiones graves.**

Este producto está destinado únicamente a la automatización de una puerta corredera de uso «residencial». La instalación de la fuente de alimentación debe cumplir con la normativa vigente en el país en el que se instale el producto (NF C 15-100 para Francia) y deberá realizarse por personal cualificado.

La red eléctrica debe estar protegida contra subidas de tensión mediante un disyuntor adaptado y un dispositivo de corriente residual.

**⚡ ATENCIÓN :** El motor debe desconectarse de la fuente de alimentación durante la limpieza, el mantenimiento y la sustitución de piezas.

La instalación requiere personal cualificado con conocimientos mecánicos y eléctricos.

Hay que asegurarse de que el rango de temperatura indicado en el motor está adaptado al lugar de instalación. El sistema de motorización solo debe repararse o sustituirse utilizando piezas originales.

- Este aparato puede utilizarse por niños a partir de 8 años y por personas con capacidades físicas, sensoriales o mentales reducidas o sin experiencia ni conocimientos, siempre que se les supervise o instruya adecuadamente sobre el uso del aparato en condiciones de seguridad e identificando los riesgos que conlleva. Los niños no deben jugar con este aparato. La limpieza y el mantenimiento por parte del usuario no deberá llevarse a cabo por niños sin supervisión.

- No se debe permitir que los niños jueguen con el aparato o con sus controles, incluidos los mandos a distancia.

- La activación del dispositivo de accionamiento manual podría provocar un movimiento incontrolado de la parte accionada debido a un fallo mecánico o a la pérdida de equilibrado.

- Antes de instalar el motor, es necesario comprobar que la parte accionada esté en buenas condiciones mecánicas, esté correctamente equilibrada y se abra y se cierre correctamente.

- El motor no puede utilizarse con una parte accionada que incorpore una cancela.

- Hay que evitar que la parte accionada y las partes fijas de alrededor se compriman como consecuencia del movimiento de apertura de la parte accionada.

- Tras la instalación, es necesario asegurarse de que el mecanismo esté bien ajustado y que el sistema de protección y cualquier dispositivo de accionamiento manual funcione correctamente.

- Hay que pegar de forma permanente la etiqueta del dispositivo de accionamiento manual en el elemento de control del dispositivo.

El mando a distancia solo debe usarse si se dispone de una visión completa de la puerta.

En caso de duda, no debe accionarse nunca el sistema, ya que podría dañarse.

## B- DESCRIPCIÓN

### B1- Contenido del kit

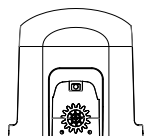

1 motor (caja electrónica + módulo Wi-Fi)

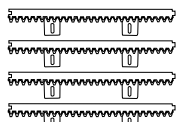

cremalleras (4m) AAM0098



2 controles remotos AAM0050



1 luz intermitente LED AAM0111

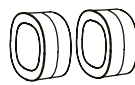

2 fotocélulas AAM0036

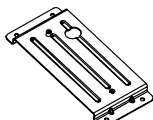

soporte de fijación motor



fines de carrera metálicas



tornillos



llave de desbloqueo



Manual

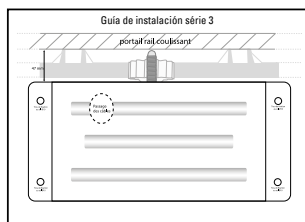

Guía de instalación

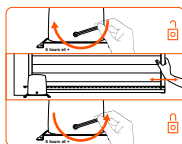

etiqueta de desbloqueo

### B2- Dimensiones

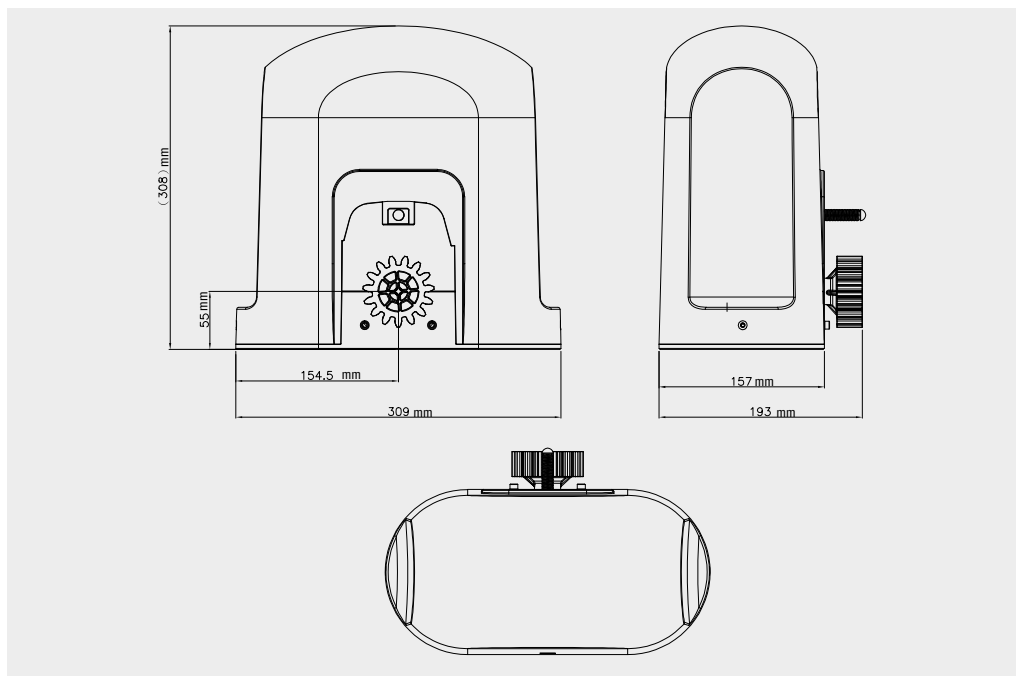

## B3- Descripción del automatismo

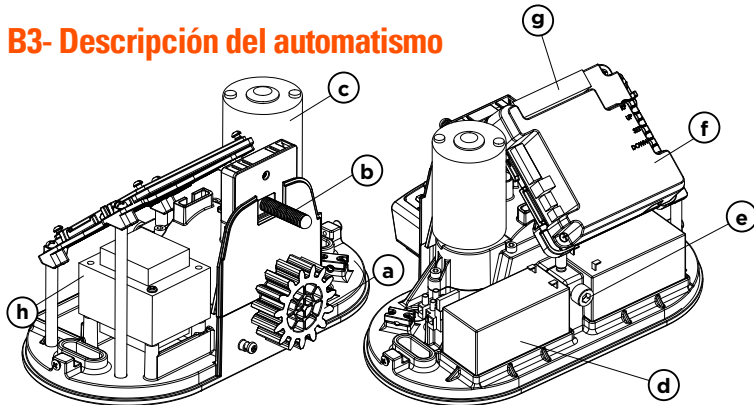

- (a) Motoreductor
- (b) Fine de carrera
- (c) Motor 24V DC
- (d) Baterías de emergencia (opción)
- (e) Desbloqueo
- (f) Tarjeta electrónica
- (g) Borne de conexión
- (h) Transformador 24V AC

## C- CABLES / INSTALACIÓN

### C1- Instalación del automatismo

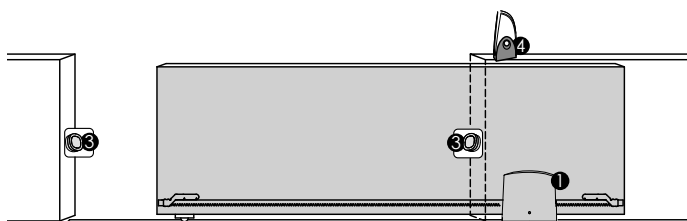

- 1 Automatismo de puerta corredera 24V
- 2 Control remoto 4 canales
- 3 Fococélulas
- 4 Luz intermitente 24V con antena integrada



### C2- Instalación del motor y de las cremalleras

Se recomienda una instalación del motor sobre una base de hormigón :

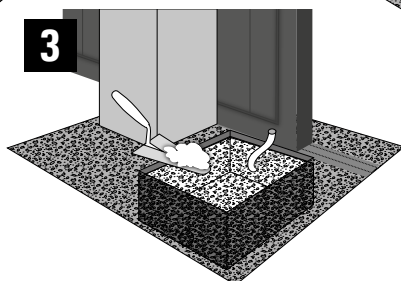
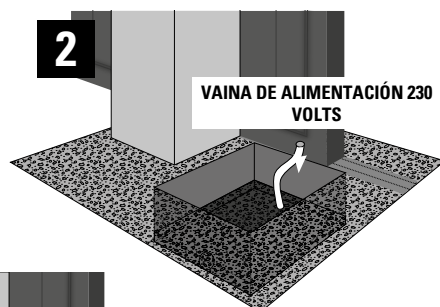
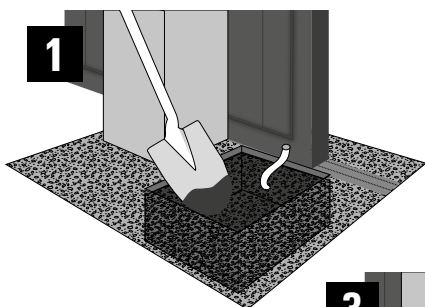

Posicionar la placa de soporte motor para determinar la posición de los orificios de perforación.  
 Tienen que ser perfectamente paralelos al portal :

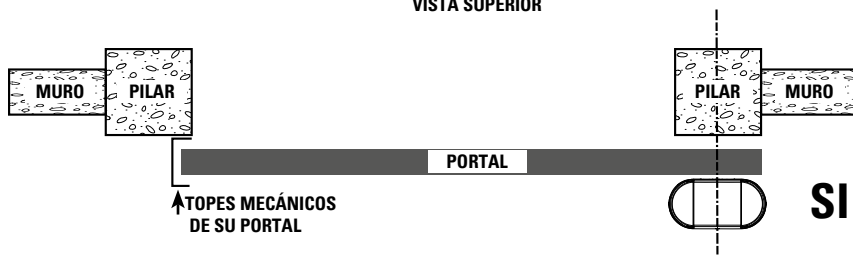
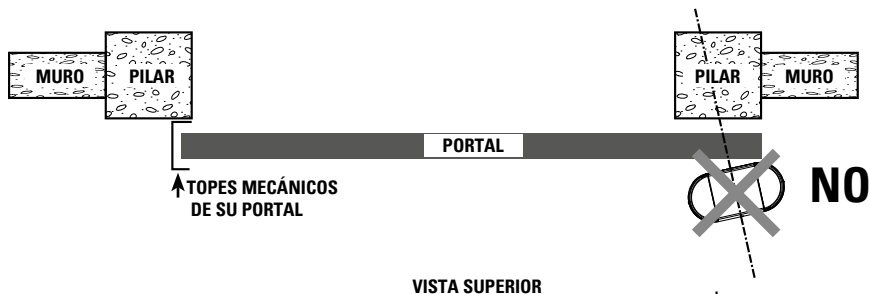
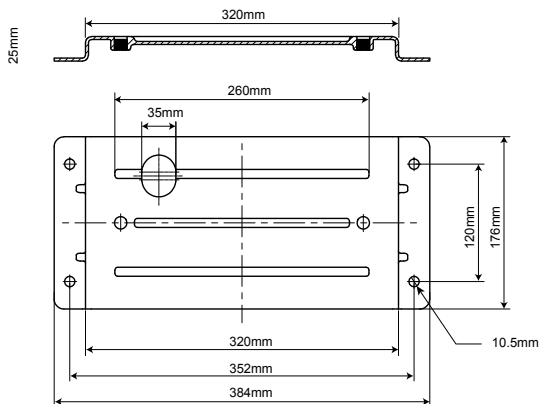

El borde de la placa de fijación se debe situar a 5 cm del borde del portal :  
 Puede utilizar la guía de instalación para facilitar la instalación

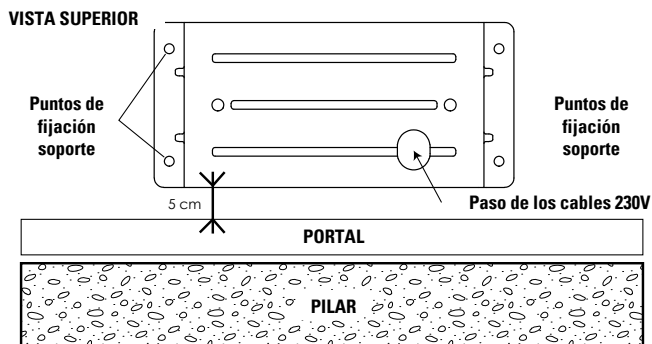

Perforar la base de soporte de hormigón e instalar los 4 tornillos metálicos o químicos para fijar su placa de soporte motor. Pasar todos los cables de alimentación y de accesorios. Asegurarse, con ayuda de un nivel a burbuja de que la placa de fijación del motor esté bien nivelado. Posicionar el motor y fijarlo con los dos tornillos incluidos.

### Fijación de las cremalleras :

Las cremalleras incluidas, en material termoplástico con inserto de acero son adecuadas para portales hasta 500 Kg. Se colocan fácilmente por simple atornillado. Suministramos los tornillos de auto perforación.

Si su portal, no permite el montaje directo de las cremalleras, será necesario crear una nueva base de apoyo :

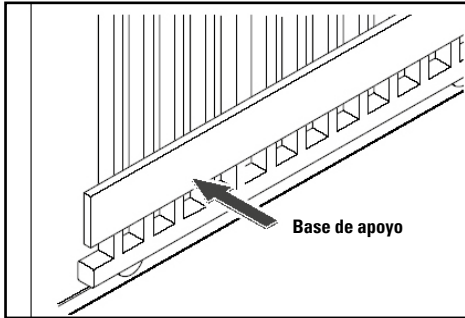

Para posicionar la primera cremallera, dejar un espacio de 2 mm entre la rueda dentada del motor et la cremallera como indicado en la ilustración siguiente :

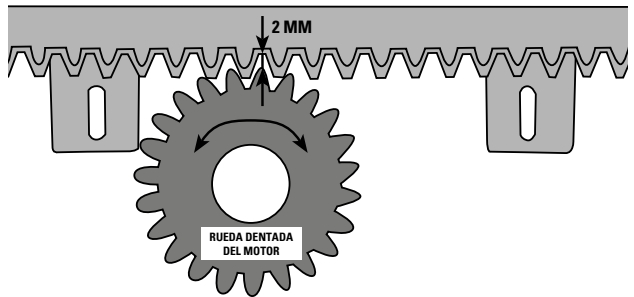

Luego trazar sus marcas para atornillar los tornillos de auto perforación como indicado a continuación :

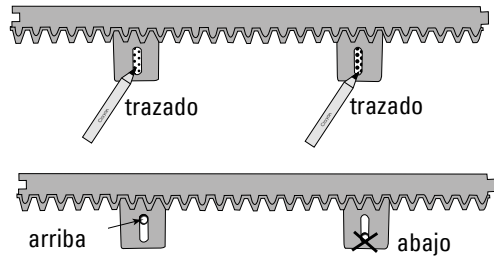
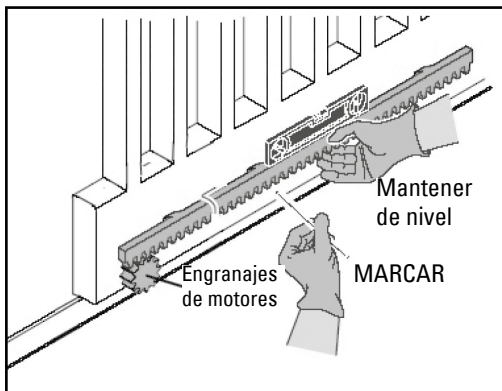

Atornillar el tornillo de auto perforación hacia la parte de arriba del agujero longitudinal de su cremallera.

Comprobar que la rueda dentada de su motor ocupe toda la superficie de la cremallera :

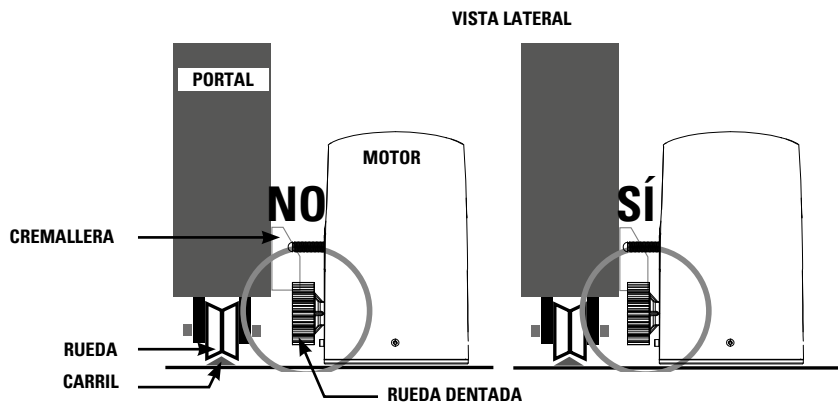

### Posicionar los finales de carrera sobre la cremallera

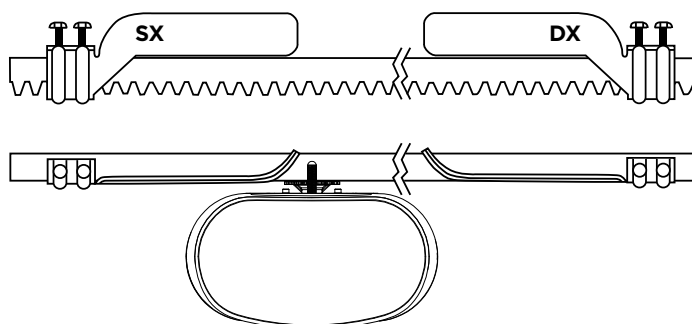

### C3- Desbloqueo manual

En caso de fallo de corriente o para programar su automatismo de portal, se puede desbloquear manualmente el motor : Desde el interior del portal, introducir la llave de seis caras utilizada para el desbloqueo, y atornillarla entre 5 y 10 veces. Se puede ahora abrir el portal a mano.

Para desbloquear de nuevo el motor, introducir la llave de seis caras utilizada para el desbloqueo, y desatornillarla entre 5 y 10 veces en el otro sentido.

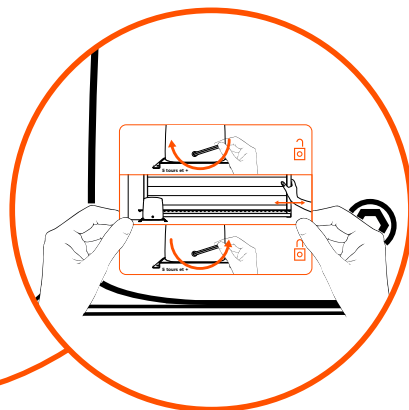
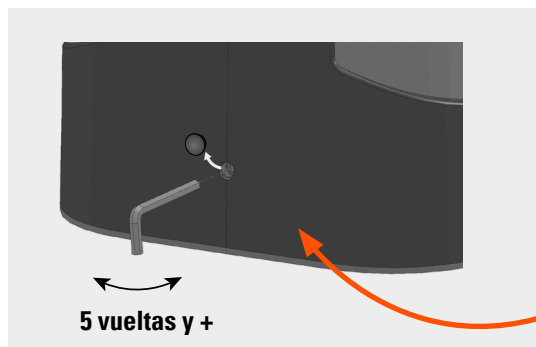

Hay que pegar de forma permanente la etiqueta del dispositivo de accionamiento manual en el elemento de control del dispositivo.

# C4- Esquema de cables

Figura 1

**cables imperativo en :**

▲ > 0.5 mm<sup>2</sup>

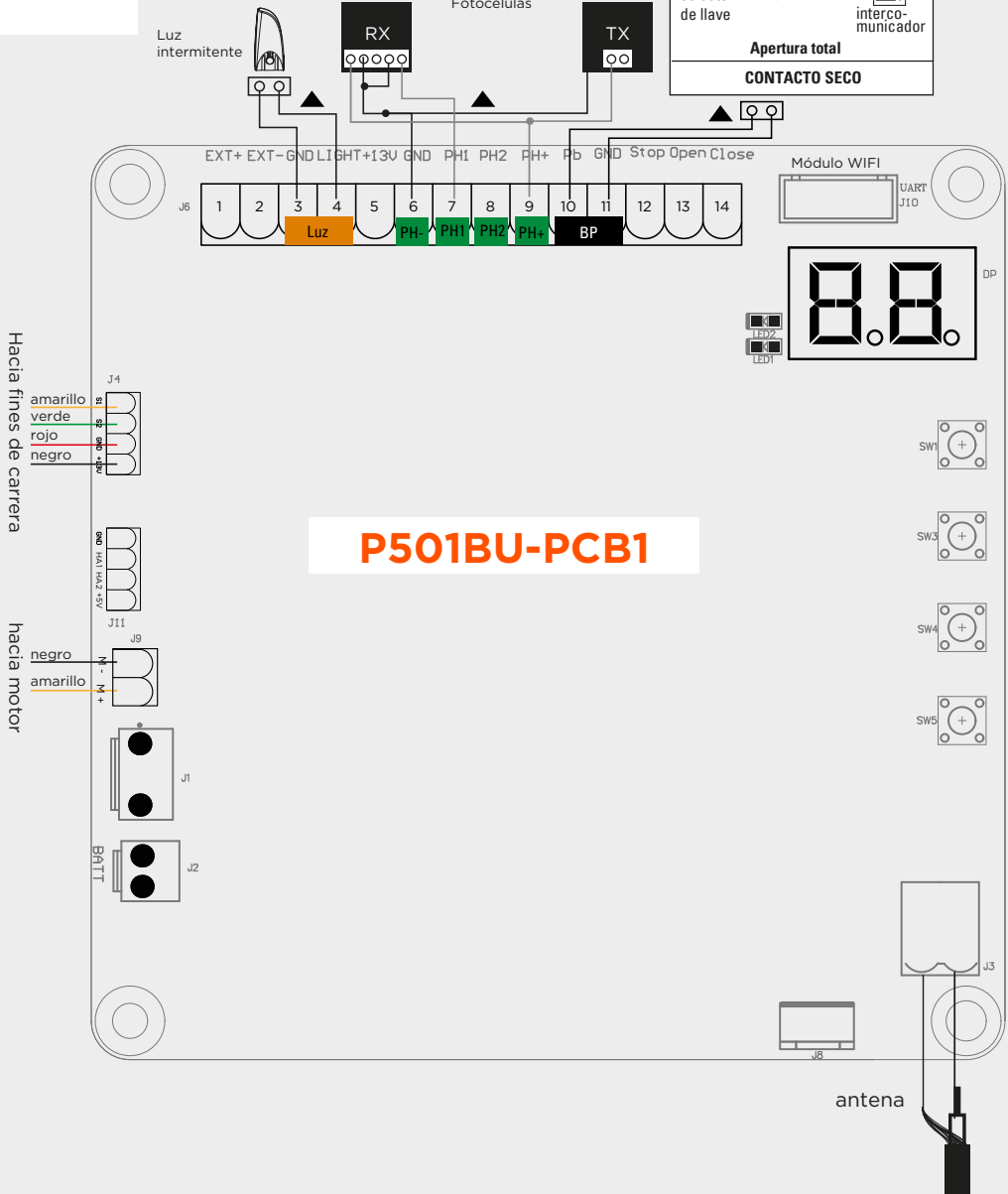
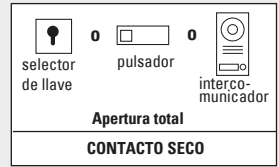

**P501BU-PCB1**

# C5- Instalación y conexión

## Cableado de la alimentación 230 volts

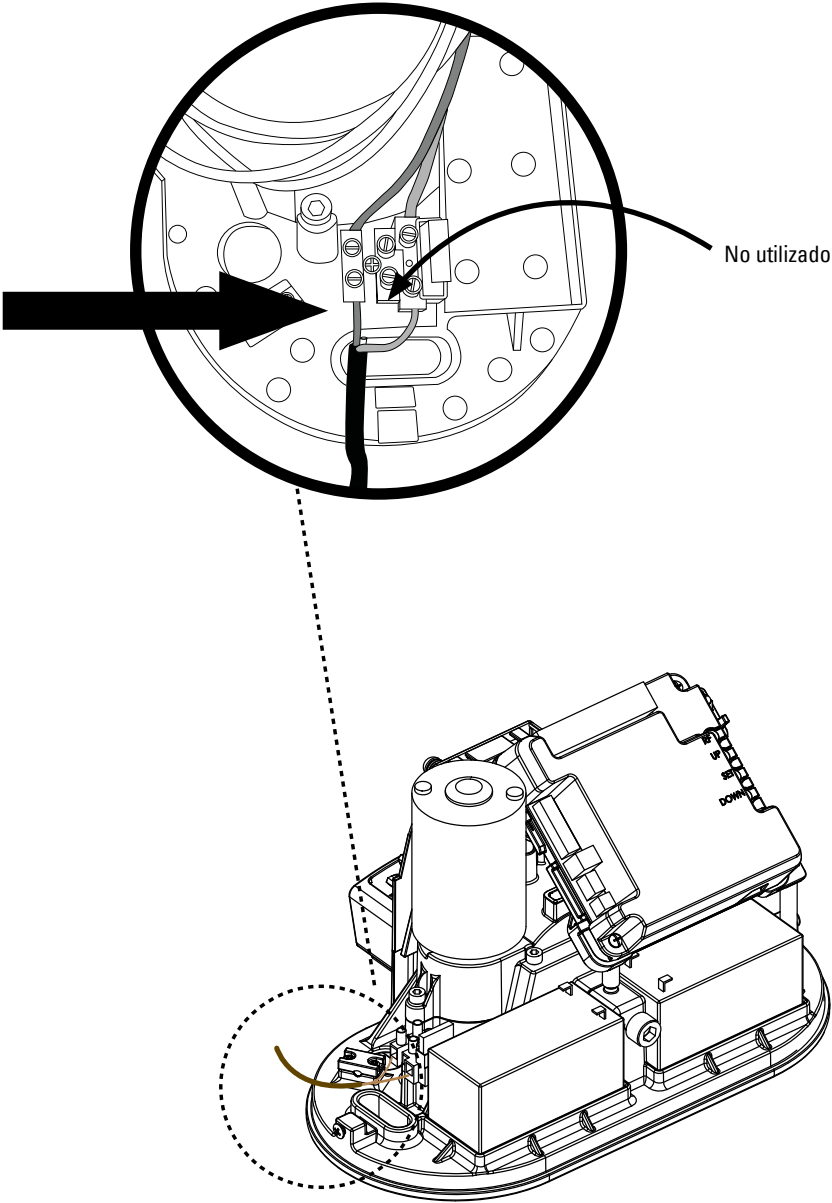



## Luz intermitente - ref AAM011

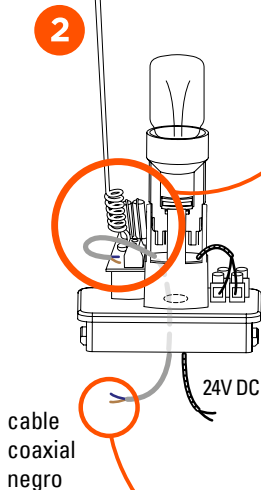
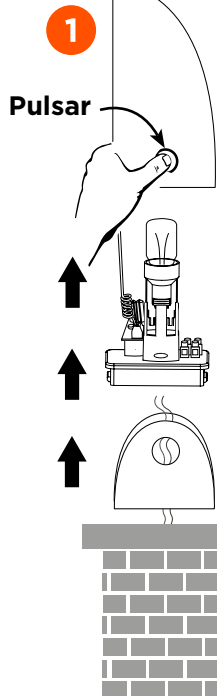

Para mejorar el alcance de sus controles remotos, se puede conectar la antena situada en la luz intermitente con un cable coaxial tipo RG58 (no suministrado). En este caso, hay que desconectar la antena de origen. Conectar el latón central del cable coaxial sobre la borna «ANT» y la trenza sobre la borna «GND», de cada lado (antena y tarjeta).

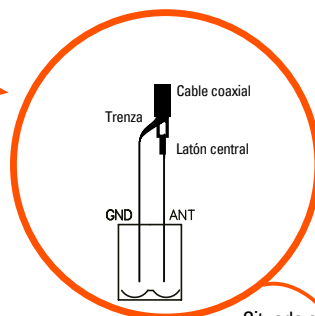

Situado en la parte superior izquierda del PCB

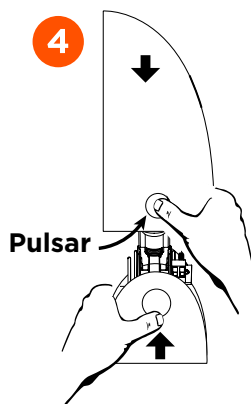
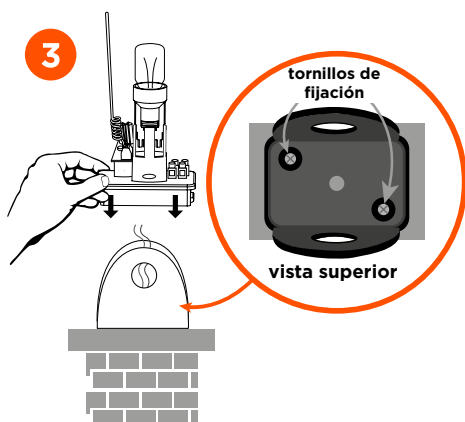

## Fotocélulas

Las fotocélulas son dispositivos de seguridad para los portales automáticos. Se componen de un transmisor y de un receptor y se activan cuando se interrumpe el haz infrarrojo.

### ETAPA 1

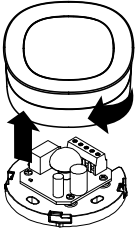

### ETAPA 2

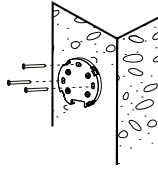

### ETAPA 3

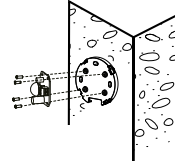

### ETAPA 4

TARJETA ELECTRÓNICA

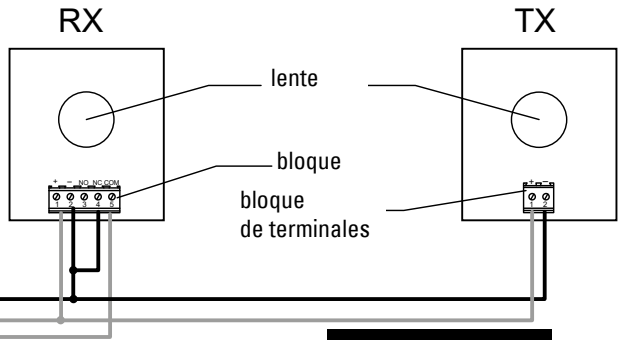
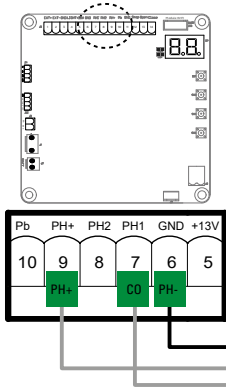

tipo de cable :  
0.5 mm<sup>2</sup>

Después del cableado de sus fotocélulas, modificar el programa H y ajustarlo en H-1 para que sus fotocélulas se activen. Si no, no tendrán ningún efecto sobre el funcionamiento de su automatismo (ver página 82)

### ETAPA 5

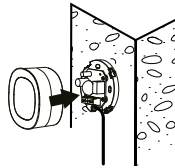

Alineación ❌

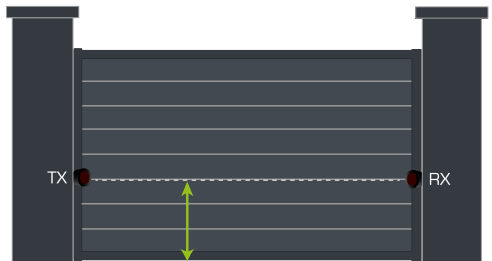

300 mm

Alineación ✅

# D- AJUSTES / USO

El automatismo se compone de un módulo Wi-Fi que le permitirá usar y parametrizar su automatismo desde su smartphone. Tiene también la posibilidad de proceder a los ajustes de manera tradicional. Los dos tipos de ajustes se diferenciarán de la manera siguiente :



Parametros tradicionales



Parametros via smartphone

## D1- Módulo Wi-Fi

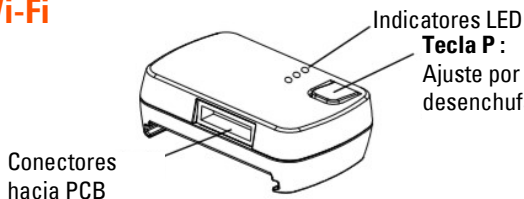

Ajuste por defecto : pulsar durante 5 sec, desenchufar y conectar el cable.

Si desea programar el módulo, pulsar la tecla P y seguir las etapas descritas en el párrafo D2

• Detalles de los LED :

Azul : El LED parpadeará durante el emparejamiento Wi-Fi, y se quedará encendido cuando el emparejamiento sea exitoso.

Verde : El LED parpadeará si el módulo Wi-Fi recibe una señal de la aplicación.

*Si el Wi-Fi está desconectado, el LED verde parpadeará continuamente y se extinguirá cuando el Wi-Fi será de nuevo conectado.*

Rojo : Sistema desconectado o contraseña Wi-Fi incorrecto.

• El alcance Wi-Fi entre la caja et el módulo Wi-Fi es de 30 m en campo libre.



Alcance en campo libre

30 m

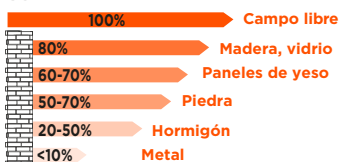

## D2- Instalación de la aplicación et de su aparato

**1** Descargar la aplicación H'Access (disponible en iOS y Android)



H'Access

**2** Registrarse con la ayuda de una contraseña y de un identificador

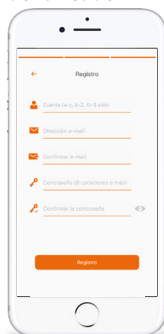

**3** Añadir su automatismo con el +

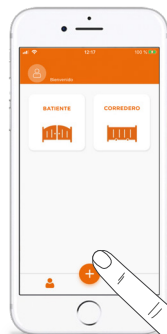

**4** Elegir el aparato que quiere añadir

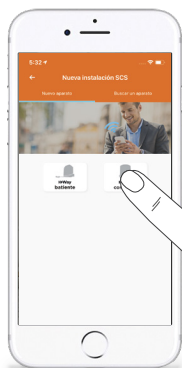

**5** Entrar el código y «validar»



**6** Seleccionar el módulo Wi-Fi

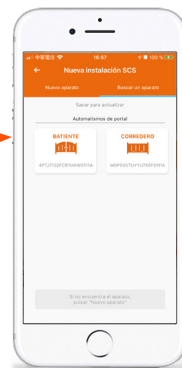

**7** Entrar un código PIN con 6 cifras pulsar «siguiente»



Es imperativo recibir una señal Wi-Fi cerca del portal para poder usar esta función. De lo contrario, usar el smartphone en modo «hotspot» durante la instalación.

## D3- Configuración y uso via smartphone

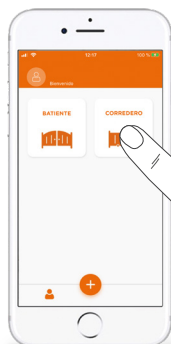

**1** Abrir la página de control de su automatismo

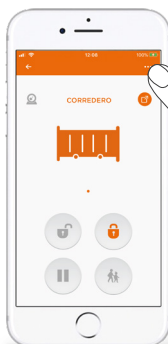

**2** Pulsar «...» arriba a la derecha de la pantalla



**3** Seleccionar «ajustes de los parámetros»



**4** Elegir la función que quiere ajustar. Si no es disponible, pulsar en el icono  arriba a la derecha de la pantalla

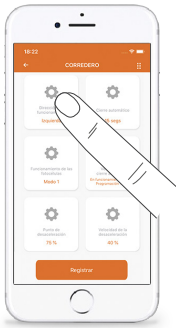

**5** Modificar el/los ajustes



**6** Si necesario, entrar el código PIN y elegir la función que quiere ajustar

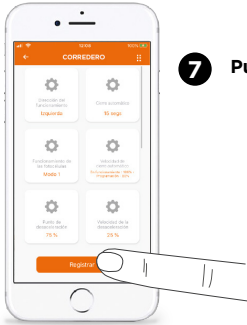

**7** Pulsar en registrar



**8** Puede ahora usar el smartphone para controlar el portal

abrir → cerrar  
pausa → apertura peatonal

## D4- Controles remotos

Programar un control remoto : Pulsar y mantener 2 segundos el pulsador « RF-Learn » el indicador LED indica «CS». Después, pulsar cualquier tecla de su control remoto, el indicador LED parpadea 2 veces y se apaga. La programación de su control remoto está efectuada (figuras 1,2 et 3)

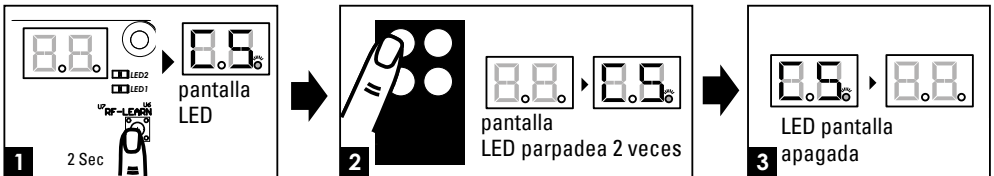

Puede ahora utilizar su control remoto de manera siguiente :

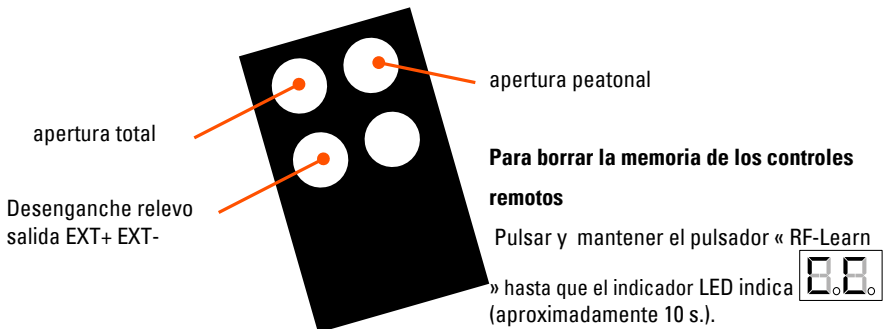

## D5- Proceso de aprendizaje, re-inicialización y el indicador LED



**Antes de proceder al aprendizaje del sistema**, el proceso de memorización del control remoto debe ser terminado.

(1) Para realizar el aprendizaje del sistema, desembragar su portal y posicionarlo a la mitad de su apertura. Desembragarlo de nuevo.

Etapa 1 : pulsar la tecla « SET », luego « SET » + « DOWN » durante 3 segundos, el indicador LED indica « LE » (Figuras 1,2 y 3, ver página siguiente)

Etapa 2 : pulsar la tecla en la parte superior izquierda de su control remoto durante 1 a 3 segundos, el indicador LED entonces indica « LP » (Figuras 4 y 5)



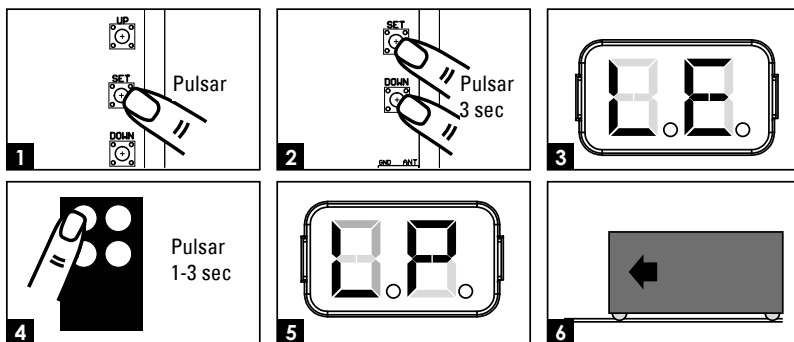

Etapa 3 : El portal efectua su autoaprendizaje, es decir que se cierra una primera vez, luego se abre y se cierra de nuevo. Esperar que el proceso este completamente terminado.

Si su portal se abre al inicio de la programación, cerrar el programa pulsando SET. «-L» aparece en la pantalla. Esperar que se apague e invertir la dirección de rotación de su portal.

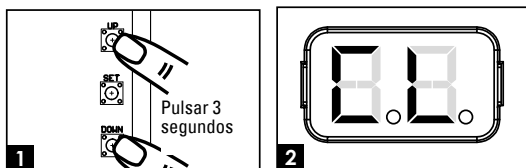

(2) Para restablecer los parámetros de fábrica, pulsar y mantener las teclas « UP » y « DOWN » durante 3 segundos, la pantalla indica « CL ».



Indicador LED	Descripción
	« -L » : el proceso de aprendizaje no está terminado.
	« OP » : funcionamiento normal del sistema. Para entrar en la programación, pulsar la tecla « SET » durante 3 segundos. Cuando el indicador LED pasa de « OP » a « 1 », pulsar las teclas « UP » y « DOWN » para recorrer las funciones programables (1 a P). Pulsar « SET » para volver en el programa elegido y pulsar luego « UP » o « DOWN » para cambiar los parámetros de la función y « SET » para confirmar.
	« LE » : entrada en el modo aprendizaje, seguir las instrucciones.
	« LP » : el sistema de aprendizaje está en curso. El proceso de autoaprendizaje es el siguiente : Apertura completa > cierre completo
	« CL » : reinicio con los parámetros de fábrica

## D6- Ajustes de las funciones programables



Para entrar en los ajustes, mantener 5 segundos la tecla «SET» . «1» aparece. Desplazar con «UP» o «DOWN» hasta la función elegida, y pulsar «SET» pour entrar en la función. Luego, modificar el valor con «UP» o «DOWN» (atención, si no se presiona ninguna tecla durante 5 segundos, el indicador sale automáticamente del modo ajuste).

Indicador LED	Definición	Función	Valor	Descripción
1	Opción de sentido de apertura del portal	1-1	Apertura hacia izquierda	Esta función permite ajustar el sentido de apertura del portal. El ajuste de fábrica es « 1-1 ».
		1-2	Apertura hacia derecha	
2	Cierre automático	2-0	No hay cierre automático	Esta función permite ajustar el cierre automático después el tiempo definido de pausa. El ajuste de fábrica es « 2-0 » : No hay cierre automático. Al pulsar simultáneamente las dos teclas de la parte superior del control remoto (puerta abierta o cerrada) se desactivará el modo automático (confirmación con 3 parpadeos de la luz intermitente). Repita la operación para reactivar el modo automático (confirmación con 3 parpadeos de la luz intermitente).
		2-1	5 segundos	
		2-2	15 segundos	
		2-3	30 segundos	
		2-4	45 segundos	
		2-5	60 segundos	
		2-6	80 segundos	
		2-7	120 segundos	
2-8	180 segundos			

3	Reacción de las fotocélulas durante una detección de obstáculo	3-1	Ver a continuación ↓	El ajuste de fábrica es « 3-1 ».
		3-2		
		3-3		
<p>3.1 : Entrada PH1 activa únicamente en el momento del cierre (reapertura total en caso de paso durante el cierre) Entrada PH2 activa sólo al abrir (re-cierre total si se pasa durante la apertura)</p> <p>3.2 : Entrada PH1 activa únicamente en el momento del cierre (reapertura total en caso de paso durante el cierre) Entrada PH2 activa en apertura y cierre (inversión durante 2 segundos si el portal está en movimiento)</p> <p>3.3 : Entrada PH1 activa únicamente en el momento del cierre (reapertura total en caso de paso durante el cierre) Entrada PH2 activa únicamente en el momento del cierre (reapertura total en caso de paso durante el cierre) Puerta cerrada y parada, un paso desencadena la apertura (total)</p>				
4	Velocidad del motor	4-1	Lento	El ajuste de fábrica es « 4-3 ».
		4-2	Medio	
		4-3	Rápido	
		4-4	Muy rápido	
5	Ajustes de la distancia de la desaceleración	5-1	75% de la distancia completa	El ajuste de fábrica es « 5-1 »
		5-2	80%	
		5-3	85%	
		5-4	90%	
		5-5	95%	
6	Velocidad de la desaceleración (% de la velocidad maxi)	6-1	80%	El ajuste de fábrica es « 6-3 »
		6-2	60%	
		6-3	40%	
		6-4	25%	
7	Fuerza del motor	7-1	2A	Esta funcionalidad permite ajustar la fuerza del motor en función del peso del portal. El ajuste de fábrica es« 7-5 ».
		7-2	3A	
		7-3	4A	
		7-4	5A	
		7-5	6A	
		7-6	7A	
8	Apertura parcial (apertura peatonal)	8-1	10%	Esta función permite ajustar la anchura de apertura parcial. El ajuste de fábrica es« 8-2 ».
		8-2	20%	
		8-3	30%	
		8-4	40%	
		8-5	50%	
		8-6	60%	



9	Parpadeo	9-0	La luz parpadea cuando el portal empieza a moverse	El ajuste de fábrica es« 9-0 ».
		9-1	La luz parpadea 3 segundos antes de que el portal empiece a moverse	

A	Inversión de sentido cuando se encuentra un obstáculo	A-0	No hay inversión	El ajuste de fábrica es« A-3 ». La función de inversión funciona sólo 3 veces y se para. En caso de inversión de sentido, la función de cierre automático está cancelada.
		A-1	Inversión durante 1 segundo	
		A-2	Inversión durante 3 segundos	
		A-3	Inversión hasta el final	
C	Tecla de control para apertura total (control remoto)	C-1	Tecla en la parte superior izquierda	El ajuste de fábrica es « C-1 ».
		C-2	Tecla en la parte superior derecha	
		C-3	Tecla en la parte inferior izquierda	
		C-4	Tecla en la parte inferior derecha	
E	Botón apertura parcial - apertura peatonal (control remoto)	E-0	No función	El ajuste de fábrica es « E-2 ».
		E-1	Tecla en la parte superior izquierda	
		E-2	Tecla en la parte superior derecha	
		E-3	Tecla en la parte inferior izquierda	
		E-4	Tecla en la parte inferior derecha	
F	Botón de control de un aparato externo (en el control remoto)	F-0	No función	El ajuste de fábrica es « F-3 ».
		F-1	Tecla en la parte superior izquierda	
		F-2	Tecla en la parte superior derecha	
		F-3	Tecla en la parte inferior izquierda	
		F-4	Tecla en la parte inferior derecha	

H	Fotocélulas 1	H-0	Inactivas	El ajuste de fábrica es « H-0 ».
		H-1	Activas	
J	Fotocélulas 2	J-0	Inactivas	El ajuste de fábrica es « J-0 »
		J-1	Activas	
L	Control de de stop	L-0	Cierra	El ajuste de fábrica es « L-0 ». salida 11 y 12
		L-1	Abre	
P	Lógica de funcionamiento control remoto	P-1	Cierra	El ajuste de fábrica es« P-1 »
		P-2	Abre	

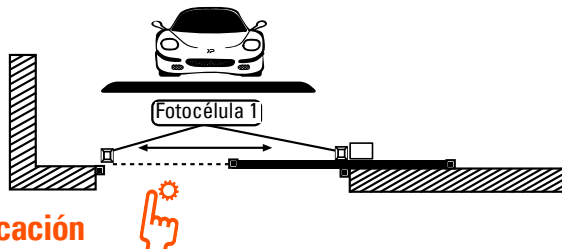

## D7- Pruebas y verificación

Efectuar las verificaciones siguientes :

- Desbloquear el motoreductor con la llave de desbloqueo.
- Asegurarse de que el portal puede desplazarse manualmente durante las fases de apertura et de cierre con una fuerza max 390N (40 kg aproximadamente).
- Bloquear el motoreductor.
- Utilizar el interruptor de llave, pulsar el botón o utilizar el control remoto, probar la apertura, el cierre y la parada del portal y asegurarse de que el portal se desplace en el sentido deseado.
- Comprobar los aparatos uno a uno (fotocélulas, interruptor de llave, etc.) para confirmar que la unidad de control reconoce cada aparato.

## D8- Indicaciones luces LED

LED	Descripción
LED 1	El LED1 se enciende cuando se encuentra un obstáculo entre las fotocélulas o un defecto de alineación o un defecto de conexión (cuidado, se debe activar la función H con una fotocélula conectada sobre PH1).
LED 2	El LED2 se enciende cuando se encuentra un obstáculo entre las fotocélulas o un defecto de alineación o un defecto de conexión (cuidado, se debe activar la función J con una fotocélula conectada sobre PH2).

## E- CARACTERÍSTICAS TÉCNICAS

### Controles remotos

Canales	4
Frecuencia - Potencia max. transmitida	433.92 MHz - potencia < 10mW
Alimentación	1 pila lithium CR2032 suministrada
Seguridad	Código secreto giratorio

## Motor

Motor	Motor 24V DC
Tipo	corredero
Régimen del motor	2600 torres/min
Peso max por batiente / Ancho máximo por batiente	500 kg / 6 m
Corriente de funcionamiento máximo	5.5A para 10 segundos max.
Temperatura de servicio	-20°C~+50°C
Velocidad	23.10 cm/s

El nivel de presión acústica emitido ponderado A de la motorización es igual o inferior a 70 dB (A).

## Luz intermitente

Antena integrada	SI (cable coaxial no suministrado)
Bombilla	1 bombilla LED (suministrada)
Cable alimentación	2 x 1 mm <sup>2</sup> (no suministrado)
Cableado bombilla	polarizado (tarjeta electrónica)
Alimentación	24 V DC
Temperatura de funcionamiento	-20°C~+50°C
Dimensiones	74 x 167 x 59 mm

## Fotocélulas

Método de detección	Haz infrarojo
Alcance	10 máximo
Tensión de entrada	AC/DC 12~24V
Plazo de respuesta	< 100ms
Indicador de funcionamiento	RX : LED rojo encendida ( Haz interrumpido) LED rojo apagada (Haz alineado) TX : LED rojo encendida (alimentación)
Dimensiones	63 x 63 x 30 mm
Tipo de salida	Salida relé

## Cremalleras

Cremalleras	12x34 cm
Material	Nailon reforzado con inserto de acero
Longitud suministrada	4 m (longitud de cada cremallera : 34 cm)

## Módulo Wifi

Frecuencia de funcionamiento	2412~2472 MHz
Potencia máxima de emisión	9,93 dBm
Normas Wi-Fi	802.11 b/g/n
Temperaturas de funcionamiento	- 20° C ~+ 50 ° C

## F- MANTENIMIENTO

Efectuar las operaciones siguientes por lo menos cada 6 meses.

En caso de uso frecuente, reducir este plazo.

### Interrumpir la alimentación:

- (1) Limpiar y engrasar los tornillos, los tarugos y la bisagra.
- (2) Verificar que los puntos de fijación queden bien apretados.
- (3) Verificar la buena conexión de los cables.

### Conectar la alimentación:

- (1) Verificar los ajustes de la alimentación.
- (2) Verificar el funcionamiento del desbloqueo manual.
- (3) Verificar el buen funcionamiento de las fotocélulas o otro dispositivo de seguridad.

## G- ASISTENCIA TÉCNICA

### G1- Ayuda de reparación

Problema encontrado	Soluciones
La puerta no se mueve cuando se acciona el control remoto	<ol style="list-style-type: none"><li>1. Verificar si el voltaje está superior a 22V.</li><li>2. Asegurarse de que todos los cables estén bien conectados a los terminales de la tarjeta electrónica.</li><li>3. Asegurarse del buen estado del fusible y del interruptor de su alimentación.</li></ol>
El portal se abre pero no se cierra	Verificar si el indicador LED1 está encendido, en cuyo caso verificar las fotocélulas, sus conexiones y su alineación. Volver al programa H a H-0 para dejar las fotocélulas inactivas durante la verificación de sus conexiones
El portal no hace su carrera entera	Aumentar la potencia con el programa 7 (ajuste de 7-1 a 7-6). Actualizar las fases de desaceleración con el programa 6 (ajuste de 6-1 a 6-4). Sin embargo por día de viento, el automatismo respeta las normas de seguridad anti-pinchazo y aplastamiento, se podrán constatar paradas pero no es un defecto de material
Las fotocélulas no funcionan	Verificar que las fotocélulas están activadas con el programa H : H-1. Verificar que el indicador rojo de la fotocélulas RX no está encendido. Si está encendido, hay un defecto de alineación de sus fotocélulas.
El alcance de los controles remotos no es satisfactorio	Verificar la tensión de las pilas. Verificar la conexión de la antena y que el alma unifilar del cable no toca la trenza.
El módulo Wi-Fi no se inscribe	<ol style="list-style-type: none"><li>1. Asegurarse de que la red Wi-Fi esté en 2,4 Ghz.</li><li>2. Reiniciar el módulo Wi-Fi:<ul style="list-style-type: none"><li>- Pulsar el botón P durante 5 segundos</li><li>- Desconectar y volver a conectar el módulo</li></ul></li></ol>

Si la adición del módulo Wi-Fi falla	<ul style="list-style-type: none"> <li>- Comprobar la conexión Wi-Fi</li> <li>- Al escribir la contraseña Wi-Fi, no escriba los espacios</li> <li>- Comprobar que ha introducido la contraseña Wi-Fi</li> <li>- Comprobar que su box está conectada a internet</li> <li>- Comprobar de que tu smartphone está en la misma red que la aplicación</li> <li>- Comprobar que la antena está atornillada antes de la instalación</li> </ul>
No puedo registrar el módulo Wi-Fi en la aplicación	Utilizar el teléfono en modo «hotspot» si no hay cobertura Wi-Fi

## G2- Ayuda por email

Se puede contactar los técnicos del servicio posventa a la siguiente dirección de email :

 [asistencia.tecnica@scs-sentinel.com](mailto:asistencia.tecnica@scs-sentinel.com)

## H- GARANTÍA



**Garantía 3 años**

SCS Sentinel concede a este producto una garantía superior a la duración legal, como referencia de calidad y fiabilidad.

**Conservar el recibo de compra durante todo este período de garantía.**

Conservar el código de barra así como que su justificante de compra, serán necesarios para hacer uso de la garantía.

**La garantía no incluye :**

- Daños materiales o eléctricos resultantes de una instalación incorrecta (error de cableado, polaridad invertida .. )
- Daños resultantes de un uso impropio de la luz intermitente (uso diferente de su origen) o de modificaciones.
- Daños resultantes del uso y/o instalación de piezas no procedentes a las previstas y incluidas por SCS Sentinel.
- Daños resultantes de una falta de mantenimiento o de un choque
- Daños resultantes de inclemencias meteorológicas como : granizo, rayo, viento fuerte, etc.
- Retorno de los artículos sin copia de factura o prueba de compra.

## I- ADVERTENCIA



No tire las pilas ni los aparatos inservibles con los residuos domésticos, ya que las sustancias peligrosas que puedan contener pueden perjudicar la salud y al medio ambiente. Pídale a su distribuidor que los recupere o utilice los medios de recogida selectiva puestos a su disposición por el ayuntamiento.





Toutes les infos sur :  
**www.scs-sentinel.com**



**SCS** sentinel

110, rue Pierre-Gilles de Gennes  
49300 Cholet - France

« Par la présente, SCS Sentinel déclare que ce produit est conforme aux exigences essentielles et autres dispositions pertinentes de la directive 2014/53/UE. La déclaration de conformité peut être consultée sur le site : [www.scs-sentinel.com/downloads](http://www.scs-sentinel.com/downloads) »

« Hereby, SCS Sentinel declares that this product complies with the essential requirements and other relevant provisions of directive 2014/53/EU. The declaration of conformity may be consulted on the website : [www.scs-sentinel.com/downloads](http://www.scs-sentinel.com/downloads) »

« Con la presente, SCS Sentinel certifica che il prodotto é conforme alle esigenze essenziali applicabili e in particolare alle esigenze della direttiva 2014/53/UE. La dichiarazione di conformità completa può essere consultata sul sito web : [www.scs-sentinel.com/downloads](http://www.scs-sentinel.com/downloads) »

« Por la presente, SCS Sentinel declara que este producto cumple con los requisitos esenciales y otras disposiciones relevantes de la directiva 2014/53/UE. La declaración de conformidad completa se puede consultar en el sitio web : [www.scs-sentinel.com/downloads](http://www.scs-sentinel.com/downloads) »